



# ESD and CLEANROOM

# GARMENTS



# OUR COMPANY'S GOAL:

---

*We are dedicated to reach our goal to make our own DLB brand a globally respected and accepted trademark of our high quality ESD products, like other trademarks of the leading manufacturers (American, German, Italian, etc. companies) of the international market.*

*With our Hungarian product development and production our aim is to provide guidance on ESD product's market and with innovations we want to improve the effectiveness of ESD protection. With this activity, we increase the security of electronics production and prevent the malfunction of electronic products by static discharge and help the safe use of them. With their work our colleagues can contribute to the proper work of lifesaving products: for example to avoid mistakes in production of car braking electronics or to provide the proper operation of medical diagnostic devices.*

*Our company ensures the livelihood of more than 80 Hungarian families and we strive with our product and market development to continue to increase D és Tsa Team.*

---

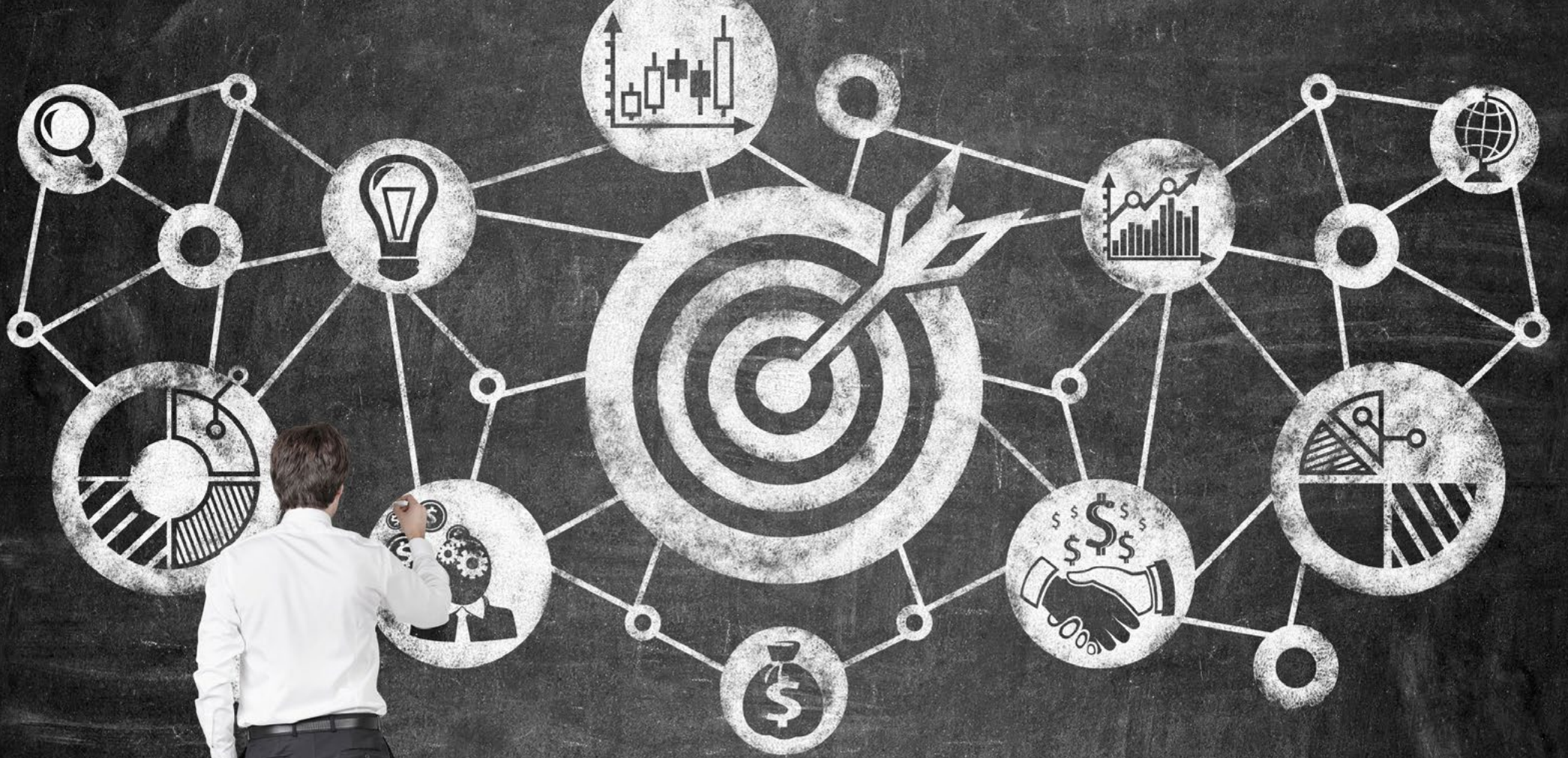



# CONTENTS

---

|                                   |     |
|-----------------------------------|-----|
| About our company                 | 6   |
| ESD Requirements                  | 8   |
| ESD Fabrics                       | 10  |
| Washing instructions and warranty | 20  |
| ECO LINE Collection               | 22  |
| STANDARD LINE Collection          | 24  |
| PREMIUM LINE Collection           | 42  |
| BUSINESS LINE Collection          | 50  |
| SUMMER LINE Collection            | 58  |
| WINTER LINE Collection            | 74  |
| Other ESD products                | 100 |
| CLEANROOM LINE Collection         | 102 |
| Size charts, figures              | 112 |
| LOGO DESIGN                       | 116 |
| Notes                             | 117 |

---

\* The product and fabric colors shown in the catalog may differ from the colors of the manufactured products due to printing, and we do not accept any responsibility for this. Please request our free fabric sample catalog. This catalog is for informational purposes only, and our company accepts no responsibility for any typographical errors (technical data, sizes, etc.) and reserves the right to make changes.

# ABOUT OUR COMPANY

D és Tsa Bt. was established in 1996. It is a 100 % Hungarian owned company. Our main business segment is to provide help in static control - we offer a large scale of products, and different services for ensure well-working ESD protection at companies. These can be helpful for providing security in electronic manufacturing and prevent the damage of electronic products by static discharge. Our business grew gradually through the years. We established our reputation both on domestic and international markets with our quality, self-produced **ESD garments**. You can purchase **ESD entrance systems**, test stations and measurement instruments with our AIJGO brand name. But we can help you with several more items too, for example:

- ✓ Cleanroom garments
- ✓ ESD Chairs
- ✓ ESD Floor mats and table mats
- ✓ ESD Packaging
- ✓ ESD Personal Protection Equipments
- ✓ ESD and Personal Protection Shoes
- ✓ Soldering Stations
- ✓ Soldering Materials
- ✓ Hand Tools

In the partner network of D és Tsa Bt. there are leading multinational electronics manufacturing corporations, which look on our company as their strategic supplier partner on ESD issues. Our outstanding results could be thank to our highly professional readiness, flexibility and the high quality standards of our sales and production. D és Tsa Bt. is a certified company on the basis of EN ISO 9001:2015 quality management system.

We offer different ESD services which prove our professionalism and made our position on the market even stronger:

- ✓ ESD training
- ✓ ESD audit
- ✓ Real-time ESD event investigation
- ✓ Project support (design, implementation, maintenance)
- ✓ ESD process and related documentation review
- ✓ EPA on-site instrumental inspections / reviews (ESD compliance testing of machinery, floor, production area, production line compliance measurement)
- ✓ Periodic compliance measurements (quarterly, semi-annual)
- ✓ ESD measuring instrument training



Our company offers good quality, self-produced ESD clothing products for Hungarian and foreign partners, which are manufactured in accordance with the current international ESD standards. Compliance with the standards is also indicated by a label with the same or similar graphics as the image to the right. If you have a specific need for ESD clothing, you can ask for our help - we can make even one piece if you need it.

**YOU DREAM IT - WE MAKE IT.**

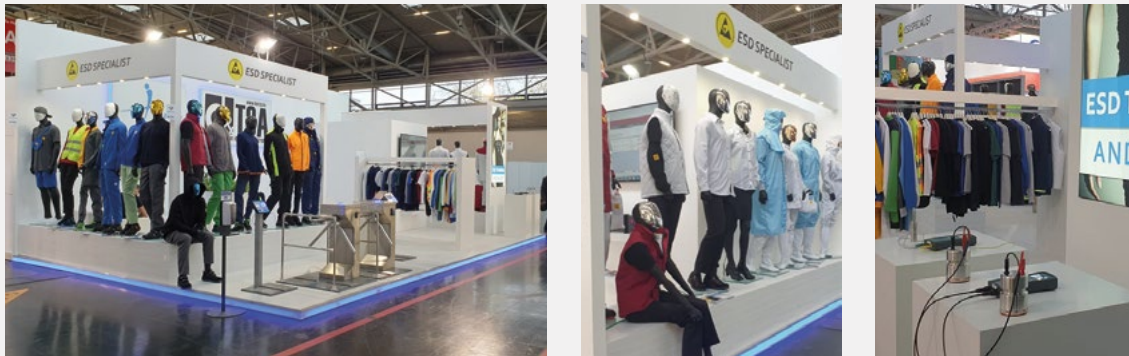

You can meet with our company and with our products on **PRODUCTRONICA** (Munich, Germany) International Trade Fair.



The quality of our products and the reliability of our company have been successfully able to hold the international markets, which resulting in that most of our production capacity is reserved for export sales.

Based on the feedbacks received from our partners, our slogan has become the following sentence:

*"D ÉS TSA BT. OFFERS NOT ONLY PRODUCT BUT COOPERATION AS WELL."*

We hope our products and services can greatly assist your work in the present and in the future.



**Balázs Dulay**  
Owner and Strategic director

# ESD REQUIREMENTS

ACCORDING TO IEC 61340-4-9:2024

| Common industry description/Use of garment system:  | Garment type:   | Test procedure:  | Specific resistance values:   |
|---|---|--|-------------------------------|
| Garments with some electrical field suppression properties  | Static control garment  | Resistance point to point  | $< 1,0 \times 10^{11} \Omega$ |
| Garments with a designated groundable point   | Groundable static control garment   | Resistance point to point and resistance point to groundable point | $< 1,0 \times 10^9 \Omega$    |
| Garment in continuous electrical path with a person; however, not the primary ground path                         | Groundable static control garment   | Resistance point to point and resistance point to groundable point | $< 1,0 \times 10^9 \Omega$    |
| Grounded with dual paths to ground via continuous monitoring equipment that requires two separate paths to ground | Groundable static control garment system (garment in combination with person) | Resistance point to point and resistance point to groundable point | $< 1,0 \times 10^9 \Omega$    |
|   |   | Integrated wrist strap in accordance with IEC 61340-4-6:2016       | $< 3,5 \times 10^7 \Omega$    |
| Grounded through a single wire constant monitor system  | Groundable static control garment system (garment in combination with person) | Resistance point to point and resistance point to groundable point | $< 1,0 \times 10^9 \Omega$    |
|   |   | Integrated wrist strap in accordance with IEC 61340-4-6:2016       | $< 3,5 \times 10^7 \Omega$    |
| Garment used as primary grounding path for personnel  | Groundable static control garment system (garment in combination with person) | Resistance point to point and resistance point to groundable point | $< 1,0 \times 10^9 \Omega$    |
|   |   | Integrated wrist strap in accordance with IEC 61340-4-6:2016       | $< 3,5 \times 10^7 \Omega$    |

**Our ESD clothing meets the above requirements!**  
 For groundable ESD protective clothing, please use the additional order codes: **GND** (see the first two images on the right: wrist strap + conductive strip + snap button on the pocket) or **GNDR** (see the third and fourth images on the right: conductive cuff fingertip + snap button on the button band).





# OEKO-TEX® STANDARD 100 CERTIFICATE – to prove that products are harmless for human health

We were granted with Oeko-Tex® Standard 100 certificate for more products from our ESD Polo-shirts and ESD T-shirts as well.

"Oeko-Tex® Standard 100 is one of the world's best-known labels for textiles tested for harmful substances."

"If a textile article carries the STANDARD 100 label, you can be certain that every component of this article, i.e. every thread, button and other accessories, has been tested for harmful substances and that the article therefore is harmless for human health."

The test is conducted by independent OEKO-TEX® partner institutes on the basis of an extensive OEKO-TEX® criteria catalog. "In the test they take into account numerous regulated and non-regulated substances, which may be harmful to human health. In many cases the limit values for the STANDARD 100 go beyond national and international requirements."

Source: <https://www.oeko-tex.com/en/our-standards/oeko-tex-standard-100>

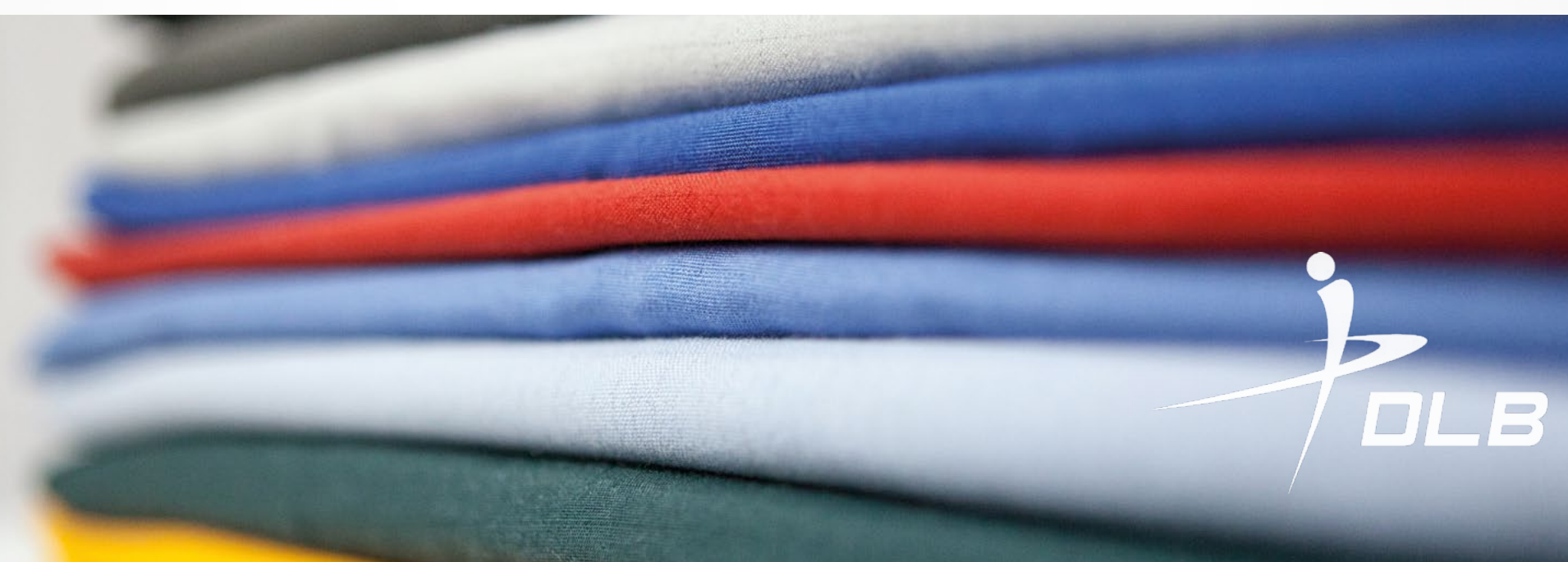















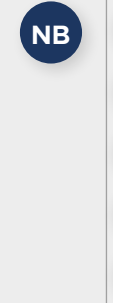

# ESD FABRICS

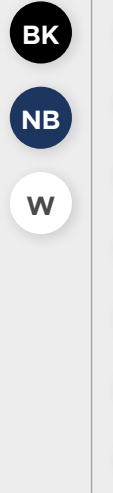
---

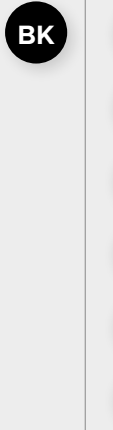
# ESD FABRICS

| Type                       | KK01   | TH55   | CT35  | TH65  | MC24  | EECO01  | CR10   | CR10HI  | WC10  | TS15   | TS16  | PS21   | LY20  | THSS   | THSB  | FL1  |
|----------------------------|--|--|---|---|---|---|--|---|---|--|---|--|---|--|---|--|
| Material                   | Woven  | Woven  | Woven   | Woven   | Woven   | Woven   | Woven (cleanroom)  | Woven (cleanroom)   | Woven (water repellent)   | Knitted  | Knitted (Pique)   | Knitted  | Knitted   | Knitted  | Knitted (Fluffy)  | Fleece   |
| Polyester (%)              | 74   | 63   | 69  | 36  | 66  | 63  | 98   | 98  | 98  | -  | -   | 47   | -   | 48   | 48  | 96   |
| Cotton (%)                 | 24   | 33   | 27  | 60  | 32  | 33  | -  | -   | -   | 96   | 96  | 50   | 88  | 48   | 48  | -  |
| Conductive fibre (%)       | 2  | 4  | 4   | 4   | 2   | 4   | 2  | 2   | 2   | 4  | 4   | 3  | 4   | 4  | 4   | 4  |
| Lycra (%)                  | -  | -  | -   | -   | -   | -   | -  | -   | -   | -  | -   | -  | 8   | -  | -   | -  |
| Weight (g/m <sup>2</sup> ) | 125  | 155  | 130   | 160   | 240   | 150   | 115  | 115   | 115   | 150  | 210   | 210  | 200   | 280  | 320   | 280  |
| Color                      |  |  |  |  |  |  |  |  |  |  |  |  |  |  |  |  |
| Page                       | 12   | 13   | 13  | 14  | 14  | 15  | 15   | 16  | 16  | 17   | 17  | 18   | 18  | 19   | 19  | 19   |

The color shades of our fabric products may vary from shipment to shipment.

# KK01 FABRIC

## FEATURES

- Static dissipative woven fabric (carbon loaded yarns in 5 mm grid)
- **Composition:** 74% Polyester, 24% Cotton, 2% Conductive fibre
- **Fabric weight:** 125 g/m<sup>2</sup>
- **Finish:** Crease resists, workwear
- **Resistance from point to point (Rp):** 10<sup>6</sup> - 10<sup>7</sup> Ohm
- **Charging time:** < 2 seconds
- Complies with IEC 61340-4-9:2024 and ANSI/ESD STM2.1:2018, and keeps this compliance after more than 50 industrial washings
- Developed for industrial washing

**!** Machine washable up to 40 °C  
 Ironing at maximum 110 °C  
 Do not use acid or alkali!  
 Drum drying with gentle programme (low temperature, maximum 50°C)  
 Do not bleach!



Detailed washing instructions and warranty conditions on page 20



## STANDARD COLORS

Black (**BK**), Dark Green (**DZ**), Dark Grey (**DG**), Grey (**GA**), Light Grey (**LG**), White (**W**), Navy Blue (**NB**), Royal Blue (**RB**), Light Blue (**LB**), Mint Green (**MG**), Light Green (**LE**), Burgundy (**B**), Red (**R**), Orange (**O**), Yellow (**Y**), Light Pink (**LPK**)

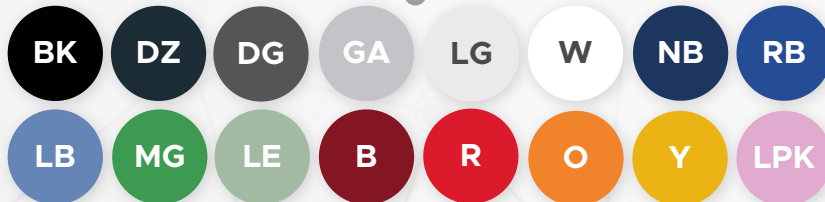

The color shades of our fabric products may vary from shipment to shipment.

**i** The availability of products manufactured from the colors shown may vary. For current expected delivery times and other requested colors please contact us.

# TH55 FABRIC

## FEATURES

- Static dissipative woven fabric (carbon loaded yarns in 5 mm grid)
- **Composition:** 63% Polyester 33% Cotton 4% Conductive fibre
- **Fabric weight:** 155 g/m<sup>2</sup>
- **Finish:** Crease resists, workwear
- **Resistance from point to point (Rp):** 10<sup>6</sup> - 10<sup>7</sup> Ohm
- **Charging time:** < 2 seconds
- Complies with IEC 61340-4-9:2024 and ANSI/ESD STM2.1:2018, and keeps this compliance after more than 50 industrial washings
- Developed for industrial washing

**!** Machine washable up to 40 °C  
 Ironing at maximum 110 °C  
 Do not use acid or alkali!  
 Drum drying with gentle programme (low temperature, maximum 50°C)  
 Do not bleach!



Detailed washing instructions and warranty conditions on page 20



## STANDARD COLORS

Royal Blue (**RB**), Light Blue (**LB**), Grey (**GA**), White (**W**)



The color shades of our fabric products may vary from shipment to shipment.

**i** The availability of products manufactured from the colors shown may vary. For current expected delivery times and other requested colors please contact us.

# CT35 FABRIC

## FEATURES

- Static dissipative woven fabric (carbon loaded yarns in 5 mm grid)
- **Composition:** 69% Polyester 27% Cotton 4% Conductive fibre
- **Fabric weight:** 130 g/m<sup>2</sup>
- **Finish:** Crease resists, workwear
- **Resistance from point to point (Rp):** 10<sup>6</sup> - 10<sup>7</sup> Ohm
- **Charging time:** < 2 seconds
- Complies with IEC 61340-4-9:2024 and ANSI/ESD STM2.1:2018, and keeps this compliance after more than 100 industrial washings
- Developed for industrial washing

Machine washable up to 40 °C  
 Ironing at maximum 110 °C  
 Do not use acid or alkali!  
 Drum drying with gentle programme (low temperature, maximum 50°C)  
 Do not bleach!



Detailed washing instructions and warranty conditions on page 20



## STANDARD COLORS

White (W)

W

The color shades of our fabric products may vary from shipment to shipment.

 The availability of products manufactured from the color shown may vary. For current expected delivery times and other requested colors please contact us.

# TH65 FABRIC

## FEATURES

- Static dissipative woven fabric (carbon loaded yarns in 5 mm grid)
- **Composition:** 36% Polyester 60% Cotton 4% Conductive fibre
- **Fabric weight:** 160 g/m<sup>2</sup>
- **Finish:** Crease resists, workwear
- **Resistance from point to point (Rp):** 10<sup>6</sup> - 10<sup>7</sup> Ohm
- **Charging time:** < 2 seconds
- Complies with IEC 61340-4-9:2024 and ANSI/ESD STM2.1:2018, and keeps this compliance after more than 50 industrial washings
- Developed for industrial washing

Machine washable up to 40 °C  
 Ironing at maximum 110 °C  
 Do not use acid or alkali!  
 Drum drying with gentle programme (low temperature, maximum 50°C)  
 Do not bleach!



Detailed washing instructions and warranty conditions on page 20



## STANDARD COLORS

White (W)

W

The color shades of our fabric products may vary from shipment to shipment.

 The availability of products manufactured from the color shown may vary. For current expected delivery times and other requested colors please contact us.

# MC24 FABRIC

## FEATURES

- > Static dissipative woven fabric
- > **Composition:** 66% Polyester, 32% Cotton, 2% Conductive fibre
- > **Fabric weight:** 240 g/m<sup>2</sup>
- > **Finish:** Workwear
- > **Resistance from point to point (Rp):** 10<sup>7</sup> - 10<sup>11</sup> Ohm
- > **Charging time:** < 2 seconds
- > Complies with IEC 61340-4-9:2024 and ANSI/ESD STM2.1:2018, and keeps this compliance after more than 50 industrial washings
- > Developed for industrial washing

! Machine washable up to 40 °C  
 Ironing at maximum 110 °C  
 Do not use acid or alkali!  
 Drum drying with gentle programme (low temperature, maximum 50°C)  
 Do not bleach!

Detailed washing instructions and warranty conditions on page 20



## STANDARD COLORS

Dark Grey (DG)

DG

The color shades of our fabric products may vary from shipment to shipment.

**i** The availability of products manufactured from the color shown may vary. For current expected delivery times and other requested colors please contact us.

# EECO01 FABRIC

## FEATURES

- > Static dissipative woven fabric (carbon loaded yarns in 4 mm grid)
- > **Composition:** 63% Polyester 33% Cotton 4% Conductive fibre
- > **Fabric weight:** 150 g/m<sup>2</sup>
- > **Finish:** Crease resists, workwear
- > **Resistance from point to point (Rp):** 10<sup>6</sup> - 10<sup>9</sup> Ohm
- > **Charging time:** < 2 seconds
- > Complies with IEC 61340-4-9:2024 and ANSI/ESD STM2 .1:2018, and keeps this compliance after more than 50 industrial washings
- > Developed for industrial washing

! Machine washable up to 40 °C  
 Ironing at maximum 110 °C  
 Do not use acid or alkali!  
 Tumble drying is prohibited  
 Do not bleach!

Detailed washing instructions and warranty conditions on page 20



## STANDARD COLORS

Light Blue (LB), White (W)

LB

W

The color shades of our fabric products may vary from shipment to shipment.

**i** The availability of products manufactured from the colors shown may vary. For current expected delivery times and other requested colors please contact us.

# CR10 FABRIC

## FEATURES

- > Static dissipative woven fabric (carbon loaded yarns in 5 mm grid)
- > Cleanroom fabric class 10000, ISO 7
- > **Composition:** 98% Polyester 2% Conductive fibre
- > **Fabric weight:** 115 g/m<sup>2</sup>
- > **Finish:** Crease resists, workwear
- > **Resistance from point to point (Rp):** 10<sup>6</sup> - 10<sup>7</sup> Ohm
- > **Charging time:** < 2 seconds
- > Complies with IEC 61340-4-9:2024 and ANSI/ESD STM2.1:2018, and keeps this compliance after more than 50 industrial washings
- > Developed for industrial washing

**!** Machine washable up to 40 °C  
 Ironing at maximum 110 °C  
 Do not use acid or alkali!  
 Tumble drying is prohibited  
 Do not bleach!



Detailed washing instructions and warranty conditions on page 20



## STANDARD COLORS

Light Blue (LB), White (W)

LB

W

The color shades of our fabric products may vary from shipment to shipment.

**i** The availability of products manufactured from the colors shown may vary. For current expected delivery times and other requested colors please contact us.

# CR10HI FABRIC

## FEATURES

- > Static dissipative woven fabric (carbon loaded yarns in 5 mm grid)
- > Cleanroom fabric class 10000, ISO 7
- > **High Visibility fabric**
- > **Composition:** 98% Polyester 2% Conductive fibre
- > **Fabric weight:** 115 g/m<sup>2</sup>
- > **Finish:** Crease resists, workwear
- > **Resistance from point to point (Rp):** 10<sup>6</sup> - 10<sup>7</sup> Ohm
- > **Charging time:** < 2 seconds
- > Complies with IEC 61340-4-9:2024 and ANSI/ESD STM2.1:2018, and keeps this compliance after more than 50 industrial washings
- > Developed for industrial washing

**!** Machine washable up to 40 °C  
 Ironing at maximum 110 °C  
 Do not use acid or alkali!  
 Tumble drying is prohibited  
 Do not bleach!



Detailed washing instructions and warranty conditions on page 20



## STANDARD COLORS

Orange (O), Yellow (Y)

O

Y

The color shades of our fabric products may vary from shipment to shipment.

**i** The availability of products manufactured from the colors shown may vary. For current expected delivery times and other requested colors please contact us.

# WC10 FABRIC

## FEATURES

- > Static dissipative woven fabric (carbon loaded yarns in 5 mm grid)
- > Water repellent material, for outdoor use
- > Cleanroom fabric class 10000, ISO 7
- > **Composition:** 98% Polyester 2% Conductive fibre
- > **Fabric weight:** 115 g/m<sup>2</sup>
- > **Finish:** Crease resists, workwear
- > **Resistance from point to point (Rp):** 10<sup>6</sup> - 10<sup>7</sup> Ohm
- > **Charging time:** < 2 seconds
- > Complies with IEC 61340-4-9:2024 and ANSI/ESD STM2.1:2018, and keeps this compliance after more than 50 industrial washings
- > Developed for industrial washing

Machine washable up to 40 °C  
 Ironing at maximum 110 °C  
 Do not use acid or alkali!  
 Drum drying with gentle programme (low temperature, maximum 50°C)  
 Do not bleach!



Detailed washing instructions and warranty conditions on page 20



## STANDARD COLORS

Navy Blue (NB)



The color shades of our fabric products may vary from shipment to shipment.

**i** The availability of products manufactured from the color shown may vary. For current expected delivery times and other requested colors please contact us.

# TS15 FABRIC

## FEATURES

- > Static dissipative knitted fabric (with carbon yarn)
- > **Composition:** 96% Cotton 4% Conductive fibre
- > **Fabric weight:** 150 g/m<sup>2</sup>
- > **Finish:** Crease resist, workwear
- > **Resistance from point to point (Rp):** 10<sup>6</sup> - 10<sup>7</sup> Ohm
- > **Charging time:** < 2 seconds
- > Complies with IEC 61340-4-9:2024 and ANSI/ESD STM2.1:2018, and keeps this compliance after more than 40 industrial washings
- > Developed for industrial washing

Machine washable up to 40 °C  
 Ironing at maximum 110 °C  
 Do not use acid or alkali!  
 Tumble drying is prohibited  
 Do not bleach!



Detailed washing instructions and warranty conditions on page 20



## STANDARD COLORS

Black (BK), Navy Blue (NB), Royal Blue (RB), Dark Grey (DG), Grey (GA), Burgundy (B), Orange (O), Dark Green (GR), White (W)



The color shades of our fabric products may vary from shipment to shipment.

**i** The availability of products manufactured from the colors shown may vary. For current expected delivery times and other requested colors please contact us.



# TS16 FABRIC

## FEATURES

- > Static dissipative knitted **PIQUE** fabric (with carbon yarn)
- > **Composition:** 96% Cotton 4% Conductive fibre
- > **Fabric weight:** 210 g/m<sup>2</sup>
- > **Finish:** Crease resists, workwear
- > **Resistance from point to point (Rp):** 10<sup>6</sup> - 10<sup>7</sup> Ohm
- > **Charging time:** < 2 seconds
- > Complies with IEC 61340-4-9:2024 and ANSI/ESD STM2.1:2018, and keeps this compliance after more than 40 industrial washings
- > Developed for industrial washing



**!** Machine washable up to 40 °C  
 Ironing at maximum 110 °C  
 Do not use acid or alkali!  
 Tumble drying is prohibited  
 Do not bleach!

Detailed washing instructions and warranty conditions on page 20



## STANDARD COLORS

Black (**BK**), Navy Blue (**NB**), White (**W**)



*The color shades of our fabric products may vary from shipment to shipment.*

**i** The availability of products manufactured from the colors shown may vary. For current expected delivery times and other requested colors please contact us.

# PS21 FABRIC

## FEATURES

- > Static dissipative knitted fabric (with carbon yarn)
- > **Composition:** 47% Polyester 50% Cotton 3% Conductive fibre
- > **Fabric weight:** 210 g/m<sup>2</sup>
- > **Finish:** Crease resists, workwear
- > **Resistance from point to point (Rp):** 10<sup>6</sup> - 10<sup>7</sup> Ohm
- > **Charging time:** < 2 seconds
- > Complies with IEC 61340-4-9:2024 and ANSI/ESD STM2.1:2018, and keeps this compliance after more than 40 industrial washings
- > Developed for industrial washing



**!** Machine washable up to 40 °C  
 Ironing at maximum 110 °C  
 Do not use acid or alkali!  
 Tumble drying is prohibited  
 Do not bleach!

Detailed washing instructions and warranty conditions on page 20



## STANDARD COLORS

Black (**BK**), Navy blue (**NB**), Royal Blue (**RB**), Purple (**PR**), Dark Grey (**DG**), Grey (**GA**), White (**W**),



*The color shades of our fabric products may vary from shipment to shipment.*

**i** The availability of products manufactured from the colors shown may vary. For current expected delivery times and other requested colors please contact us.

# LY20 FABRIC

## FEATURES

- > Static dissipative knitted fabric (with carbon yarn)
- > **Composition:** 88% Cotton 8% Lycra 4% Conductive fibre
- > **Fabric weight:** 200 g/m<sup>2</sup>
- > **Finish:** Crease resists, workwear
- > **Resistance from point to point (Rp):** 10<sup>6</sup> - 10<sup>7</sup> Ohm
- > **Charging time:** < 2 seconds
- > Complies with IEC 61340-4-9:2024 and ANSI/ESD STM2.1:2018, and keeps this compliance after more than 40 industrial washings
- > Developed for industrial washing

 Machine washable up to 40 °C  
 Ironing at maximum 110 °C  
 Do not use acid or alkali!  
 Tumble drying is prohibited  
 Do not bleach!

Detailed washing instructions and warranty conditions on page 20



## STANDARD COLORS

Black (BK)



The color shades of our fabric products may vary from shipment to shipment.

**i** The availability of products manufactured from the color shown may vary. For current expected delivery times and other requested colors please contact us.

# THSS FABRIC

## FEATURES

- > Static dissipative knitted fabric (with carbon yarn)
- > **Composition:** 48% Polyester 48% Cotton 4% Conductive fibre
- > **Fabric weight:** 280 g/m<sup>2</sup>
- > **Finish:** Crease resists, workwear
- > **Resistance from point to point (Rp):** 10<sup>6</sup> - 10<sup>7</sup> Ohm
- > **Charging time:** < 2 seconds
- > Complies with IEC 61340-4-9:2024 and ANSI/ESD STM2.1:2018, and keeps this compliance after more than 40 industrial washings
- > Developed for industrial washing

 Machine washable up to 40 °C  
 Ironing at maximum 110 °C  
 Do not use acid or alkali!  
 Tumble drying is prohibited  
 Do not bleach!

Detailed washing instructions and warranty conditions on page 20



## STANDARD COLORS

Black (BK), Navy blue (NB), Royal blue (RB), Yellow (Y), Grey (GA), White (W)



The color shades of our fabric products may vary from shipment to shipment.

**i** The availability of products manufactured from the colors shown may vary. For current expected delivery times and other requested colors please contact us.

# THSB FABRIC

## FEATURES

- > Static dissipative knitted fabric (with carbon yarn)
- > Fluffy inner side
- > **Composition:** 48% Polyester 48% Cotton 4% Conductive fibre
- > **Fabric weight:** 320 g/m<sup>2</sup>
- > **Finish:** Crease resists, workwear
- > **Resistance from point to point (Rp):** 10<sup>6</sup> - 10<sup>7</sup> Ohm
- > **Charging time:** < 2 seconds
- > Complies with IEC 61340-4-9:2024 and ANSI/ESD STM2.1:2018, and keeps this compliance after more than 40 industrial washings
- > Developed for industrial washing

! Machine washable up to 40 °C  
Ironing at maximum 110 °C  
Do not use acid or alkali!  
Tumble drying is prohibited  
Do not bleach!



Detailed washing instructions and warranty conditions on page 20



## STANDARD COLORS

Black (BK), Royal blue (RB)



The color shades of our fabric products may vary from shipment to shipment.

**i** The availability of products manufactured from the colors shown may vary. For current expected delivery times and other requested colors please contact us.

# FL1 FABRIC

## FEATURES

- > Static dissipative knitted fabric (with carbon yarn)
- > **Composition:** 96% Polyester 4% Conductive fibre
- > **Fabric weight:** 280 g/m<sup>2</sup>
- > **Finish:** Fleece
- > **Resistance from point to point (Rp):** 10<sup>9</sup> - 10<sup>11</sup> Ohm
- > **Charging time:** < 2 seconds
- > Complies with IEC 61340-4-9:2024 and ANSI/ESD STM2.1:2018, and keeps this compliance after more than 40 industrial washings
- > Developed for industrial washing

! Machine washable up to 40 °C  
Ironing at maximum 110 °C  
Do not use acid or alkali!  
Tumble drying is prohibited  
Do not bleach!



Detailed washing instructions and warranty conditions on page 21



## STANDARD COLORS

Black (BK), Navy blue (NB), Dark grey (DG), Orange (O), Yellow (Y)



The color shades of our fabric products may vary from shipment to shipment.

**i** The availability of products manufactured from the colors shown may vary. For current expected delivery times and other requested colors please contact us.

# ○ WASHING INSTRUCTIONS

Conductive carbon fibres used in ESD fabrics are very sensitive to high temperatures, alkalis, acids, rinses (softeners) and bleaches. Inadequate use may cause damage to carbon fibres and ESD clothing may lose or significantly deteriorate ESD parameters. Therefore, wash ESD clothing very carefully, in each case please follow the instructions:

## KK01, TH55, CT35, TH65, MC24, WC10 FABRICS

- i** In order to preserve the long life of ESD clothings, please use industrial laundries who can provide controlled, documented washing procedures and environment
- i** Wash in cold or not warmer than 40 °C (104 °F) lukewarm water with neutral liquid detergent
- i** Do not use detergents and / or rinse aids that contain bleach and / or chlorine
- i** Bleachers are forbidden
- i** Do not use rinse aids or detergents with a high alkali or high acid content
- i** Do not dry clean
- i** Dry in the open air and / or with drum drying with gentle programme (low temperature, maximum 50 °C (120 °F))
- i** Does not require ironing, but if absolutely necessary, iron at a maximum temperature of 110 °C (230 °F) without steaming
- i** Wash all items inside out
- i** Using deodorant can damage the color of the product
- i** When drying clothes outdoors, do not expose them to direct sunlight
- i** Tighten the zippers before each wash



## CR10, CR10HI, TS15, TS16, PS21, LY20, THSS, THSB, EECO01 FABRICS

- i** In the case of knitted fabrics (TS15, TS16, PS21, LY20, THSS, THSB) we suggest to determine personal size with measurement on washed clothes. The sizes given by us in size charts meant values before washing regarding products made from these fabrics.
- i** We recommend, in order to preserve the conductivity of the garment in the long term, to entrust washing and drying processes to an industrial laundry where they can provide the necessary technological processes and conditions (documented washing procedures and suitable environment). Adapt the associated cleaning processes to the production technology (e.g. cleanroom requirements) of the product at the place of use.
- i** If the used production technology does not require specific cleaning processes, do washing in cold or lukewarm water at a temperature not warmer than 40 °C (104 °F) with neutral (liquid) detergent.
- i** Ironing of the garment is not necessary or recommended. If the user does iron the garment, iron at a maximum temperature of 110 °C (230 °F) without steaming.
- i** Bleachers are forbidden. Do not use rinse aids or detergents with a high alkali or acid content. Do not use detergents and / or rinse aids that contain bleach and / or chlorine.
- i** Do not use perfumes and deodorants as they may damage the fabric and the color of the product
- i** Do not dry clean. Tumble drying is prohibited.
- i** Wash all garments inside out
- i** Do not expose clothing to direct UV rays. Tighten the zippers before each wash





## FL1 FABRIC

- i** In order to preserve the long life of ESD clothings, please use industrial laundries who can provide controlled, documented washing procedures and environment
- i** Wash in cold or not warmer than 40 °C (104 °F) lukewarm water with neutral liquid detergent
- i** Do not use detergents and / or rinse aids that contain bleach and / or chlorine
- i** Bleachers are forbidden
- i** Do not use rinse aids or detergents with a high alkali or high acid content
- i** Do not dry clean
- i** Dry in the open air. Tumble drying is prohibited. After centrifugation, hang dry only
- i** Does not require ironing, but if absolutely necessary, iron at a maximum temperature of 110 °C (230 °F) without steaming
- i** Wash all items inside out
- i** Using deodorant can damage the color of the product
- i** When drying clothes outdoors, do not expose them to direct sunlight
- i** Tighten the zippers before each wash



## WARRANTY

- !** The warranty is strictly valid under controlled and documented industrial laundry conditions, concern the fabric washing cycle as specified in the technical data's.
- !** The warranty is NOT valid if the washing process is made in home environment!
- !** The warranty covers ESD parameters and possible sewing errors according to IEC 61340-4-9:2024 and ANSI/ESD STM2.1:2018 standard issued only!
- !** The warranty does not cover the size and shrinkage differences within the tolerances given at the size charts!
- !** Our clothing products are provided with the "Operating instructions with symbols" according to the MSZ EN ISO 3758:2012 standard.
- !** If the product shows improper tampering (e.g. tread extension or tearing), the complaint can be rejected.



# ECO LINE

---

CLOTHING STYLES

# ECO ESL ESD SMOCK

2/3 LENGTH

## FEATURES

- » Standard sizes: unisex XS - 5XL
- » 2 side pockets, 1 breast pocket with ESD symbol
- » Hidden snap-fasteners
- » Cuff with snap-fasteners

## STANDARD FABRICS AND COLORS

EECO01 FABRIC



You can contact us too for customized embroidered or screen printed company logos, lettering, custom designed ESD clothing.



## ORDERING CODE SAMPLE

**ESL** - **EECO01** - **W** **L**  
 style fabric color size

VIDEO / WEBPAGE



DETAILS ON PAGE 113

| SIZE CHART (CM) | XS | S  | M   | L   | XL  | XXL | 3XL | 4XL | 5XL |
|-----------------|----|----|-----|-----|-----|-----|-----|-----|-----|
| Cuff            | 32 | 33 | 34  | 35  | 36  | 36  | 37  | 37  | 38  |
| Sleeve          | 57 | 59 | 63  | 67  | 71  | 71  | 73  | 73  | 74  |
| Length          | 89 | 91 | 93  | 95  | 99  | 101 | 103 | 105 | 107 |
| Chest           | 90 | 98 | 106 | 114 | 122 | 130 | 136 | 142 | 148 |
| Hip             | 90 | 98 | 106 | 114 | 122 | 130 | 136 | 142 | 148 |
| Shoulder        | 36 | 39 | 42  | 45  | 48  | 51  | 54  | 57  | 60  |

Size tolerance (before washing): 2%



Clothing certified according to the international ESD standards, as indicated by this/similar label



# STANDARD LINE

---

CLOTHING STYLES





24

**ESS ESD SMOCK**

1/2 LENGTH



25

**EFS ESD SMOCK**

1/2 LENGTH



26

**ESL ESD SMOCK**

2/3 LENGTH



27

**EFL ESD SMOCK**

2/3 LENGTH



28

**ESX ESD SMOCK**

1/3 LENGTH



29

**EFX ESD SMOCK**

1/3 LENGTH



30

**ET ESD MALE  
TROUSERS**



31

**ETF ESD FEMALE  
TROUSERS**



32

**OT ESD TROUSERS  
WITH BRIDLES**



33

**OJ ESD JACKET**



34

**HIV ESD HIGH  
VISIBILITY VEST**



36

**KOT ESD TABARD**



37

**APR ESD APRON**



38

**BB ESD  
BASEBALL STYLE CAP**



39

**BP ESD  
CAP WITH NET**

# ESS ESD SMOCK

1/2 LENGTH

## FEATURES

- » Standard sizes: Unisex XS - 5XL
- » 2 side pockets, 1 breast pocket with ESD logo
- » Hidden snap-fasteners
- » Cuff with snap-fasteners\*

## STANDARD FABRICS AND COLORS

|             |    |    |    |     |             |    |               |             |   |             |
|-------------|----|----|----|-----|-------------|----|---------------|-------------|---|-------------|
| KK01 FABRIC |    |    |    |     | TH55 FABRIC |    |               | CT35 FABRIC |   | TH65 FABRIC |
| BK          | DZ | DG | GA | LG  | RB          | LB | GA            | W           | W | W           |
| NB          | RB | LB | MG | LE  | CR10 FABRIC |    | CR10HI FABRIC |             |   |             |
| B           | R  | O  | Y  | LPK | LB          | W  | O             | Y           |   |             |
| W           |    |    |    |     |             |    |               |             |   |             |

**i** You can contact us too for customized embroidered or screen printed company logos, lettering, custom designed ESD clothing.

OPTIONAL

SHORT SLEEVED VERSION - CODE: SSL

|                 |                             |               |
|-----------------|-----------------------------|---------------|
| STANDING COLLAR | CONDUCTIVE ELASTICATED CUFF | WAIST KNITTER |
|                 |                             |               |
| CODE: AGL       | CODE: RAN                   | CODE: OTO     |

GROUNDING SMOCK - CODE: GND/GNDR



DEMO VIDEO



## ORDERING CODE SAMPLE

**ESS** - **KK01** - **LB** **L** + **DLB** - **RAN** - **W**  
 style fabric color size option color

DETAILS ON PAGE 113

Clothing certified according to the international ESD standards, as indicated by this/similar label



| SIZE CHART (CM) | XS | S  | M   | L   | XL  | XXL | 3XL | 4XL | 5XL |
|-----------------|----|----|-----|-----|-----|-----|-----|-----|-----|
| Cuff            | 32 | 33 | 34  | 35  | 36  | 36  | 37  | 37  | 38  |
| Sleeve          | 57 | 59 | 63  | 67  | 71  | 71  | 73  | 73  | 74  |
| Length          | 78 | 80 | 82  | 84  | 88  | 90  | 92  | 94  | 96  |
| Chest           | 90 | 98 | 106 | 114 | 122 | 130 | 136 | 142 | 148 |
| Hip             | 90 | 98 | 106 | 114 | 122 | 130 | 136 | 142 | 148 |
| Shoulder        | 36 | 39 | 42  | 45  | 48  | 51  | 54  | 57  | 60  |

Size tolerance (before washing): 2%

\*The picture is with conductive elasticated cuff, which is optional, not standard design

# EFS ESD SMOCK

1/2 LENGTH

## FEATURES

- » Standard sizes: Female XS - 5XL
- » 2 side pockets, 1 breast pocket with ESD logo
- » Hidden snap-fasteners
- » Cuff with snap-fasteners\*

## STANDARD FABRICS AND COLORS

**KK01 FABRIC**      **TH55 FABRIC**      **CT35 FABRIC**      **TH65 FABRIC**

BK DZ DG GA LG RB LB GA W W W

NB RB LB MG LE CR10 FABRIC CR10HI FABRIC

B R O Y LPK LB W O Y

W

You can contact us too for customized embroidered or screen printed company logos, lettering, custom designed ESD clothing.



## ORDERING CODE SAMPLE

**EFS** - **KK01** - **W L** + DLB - **RAN** - **W**

style fabric color size option color

DEMO VIDEO



DETAILS ON PAGE 113

| SIZE CHART (CM) | XS | S  | M   | L   | XL  | XXL | 3XL | 4XL | 5XL |
|-----------------|----|----|-----|-----|-----|-----|-----|-----|-----|
| Cuff            | 32 | 33 | 34  | 35  | 36  | 36  | 37  | 37  | 38  |
| Sleeve          | 57 | 59 | 63  | 67  | 71  | 71  | 73  | 73  | 74  |
| Length          | 78 | 80 | 82  | 84  | 88  | 90  | 92  | 94  | 96  |
| Chest           | 90 | 98 | 106 | 114 | 122 | 130 | 136 | 142 | 148 |
| Hip             | 90 | 98 | 106 | 114 | 122 | 130 | 136 | 142 | 148 |
| Shoulder        | 36 | 39 | 42  | 45  | 48  | 51  | 54  | 57  | 60  |

Size tolerance (before washing): 2%



Clothing certified according to the international ESD standards, as indicated by this/similar label

\*The picture is with conductive elasticated cuff, which is optional, not standard design

# ESL ESD SMOCK

2/3 LENGTH

## FEATURES

- » Standard sizes: Unisex XS - 5XL
- » 2 side pockets, 1 breast pocket with ESD logo
- » Hidden snap-fasteners
- » Cuff with snap-fasteners

## STANDARD FABRICS AND COLORS

|             |    |    |    |     |             |    |               |             |   |             |
|-------------|----|----|----|-----|-------------|----|---------------|-------------|---|-------------|
| KK01 FABRIC |    |    |    |     | TH55 FABRIC |    |               | CT35 FABRIC |   | TH65 FABRIC |
| BK          | DZ | DG | GA | LG  | RB          | LB | GA            | W           | W | W           |
| NB          | RB | LB | MG | LE  | CR10 FABRIC |    | CR10HI FABRIC |             |   |             |
| B           | R  | O  | Y  | LPK | LB          | W  | O             | Y           |   |             |
| W           |    |    |    |     |             |    |               |             |   |             |

OPTIONAL

SHORT SLEEVED VERSION - CODE: SSL

|                 |                             |               |
|-----------------|-----------------------------|---------------|
| STANDING COLLAR | CONDUCTIVE ELASTICATED CUFF | WAIST KNITTER |
|                 |                             |               |
| CODE: AGL       | CODE: RAN                   | CODE: OTO     |

GROUNDING SMOCK - CODE: GND/GNDR



DEMO VIDEO



## ORDERING CODE SAMPLE

**ESL** - **KK01** - **W L**  
 style fabric color size



You can contact us too for customized embroidered or screen printed company logos, lettering, custom designed ESD clothing.

DETAILS ON PAGE 113

Clothing certified according to the international ESD standards, as indicated by this/similar label



| SIZE CHART (CM) | XS | S  | M   | L   | XL  | XXL | 3XL | 4XL | 5XL |
|-----------------|----|----|-----|-----|-----|-----|-----|-----|-----|
| Cuff            | 32 | 33 | 34  | 35  | 36  | 36  | 37  | 37  | 38  |
| Sleeve          | 57 | 59 | 63  | 67  | 71  | 71  | 73  | 73  | 74  |
| Length          | 89 | 91 | 93  | 95  | 99  | 101 | 103 | 105 | 107 |
| Chest           | 90 | 98 | 106 | 114 | 122 | 130 | 136 | 142 | 148 |
| Hip             | 90 | 98 | 106 | 114 | 122 | 130 | 136 | 142 | 148 |
| Shoulder        | 36 | 39 | 42  | 45  | 48  | 51  | 54  | 57  | 60  |

Size tolerance (before washing): 2%

# EFL ESD SMOCK

2/3 LENGTH

## FEATURES

- » Standard sizes: Female XS - 5XL
- » 2 side pockets, 1 breast pocket with ESD logo
- » Hidden snap-fasteners
- » Cuff with snap-fasteners

## STANDARD FABRICS AND COLORS

### KK01 FABRIC



### TH55 FABRIC



### CT35 FABRIC



### TH65 FABRIC



### CR10 FABRIC



### CR10HI FABRIC



## ORDERING CODE SAMPLE

**EFL** - **TH55** - **LB** **L**  
 style fabric color size

## DEMO VIDEO

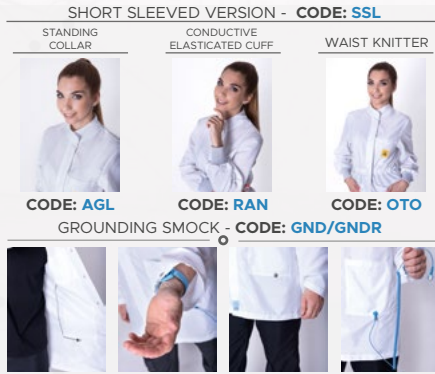

OPTIONAL

SHORT SLEEVED VERSION - CODE: SSL

STANDING COLLAR

CONDUCTIVE ELASTICATED CUFF

WAIST KNITTER



CODE: AGL



CODE: RAN

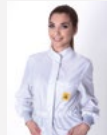

CODE: OTO

GROUNDING SMOCK - CODE: GND/GNDR



You can contact us too for customized embroidered or screen printed company logos, lettering, custom designed ESD clothing.

DETAILS ON PAGE 113

| SIZE CHART (CM) | XS | S  | M   | L   | XL  | XXL | 3XL | 4XL | 5XL |
|-----------------|----|----|-----|-----|-----|-----|-----|-----|-----|
| Cuff            | 32 | 33 | 34  | 35  | 36  | 36  | 37  | 37  | 38  |
| Sleeve          | 57 | 59 | 63  | 67  | 71  | 71  | 73  | 73  | 74  |
| Length          | 89 | 91 | 93  | 95  | 99  | 101 | 103 | 105 | 107 |
| Chest           | 90 | 98 | 106 | 114 | 122 | 130 | 136 | 142 | 148 |
| Hip             | 90 | 98 | 106 | 114 | 122 | 130 | 136 | 142 | 148 |
| Shoulder        | 36 | 39 | 42  | 45  | 48  | 51  | 54  | 57  | 60  |

Size tolerance (before washing): 2%



Clothing certified according to the international ESD standards, as indicated by this/similar label

# ESX ESD SMOCK

1/3 LENGTH

## FEATURES

- » Standard sizes: Unisex XS - 5XL
- » 2 side pockets, 1 breast pocket with ESD logo
- » Hidden snap-fasteners
- » Cuff with snap-fasteners

## STANDARD FABRICS AND COLORS

|             |    |    |    |     |             |    |               |             |   |             |
|-------------|----|----|----|-----|-------------|----|---------------|-------------|---|-------------|
| KK01 FABRIC |    |    |    |     | TH55 FABRIC |    |               | CT35 FABRIC |   | TH65 FABRIC |
| BK          | DZ | DG | GA | LG  | RB          | LB | GA            | W           | W | W           |
| NB          | RB | LB | MG | LE  | CR10 FABRIC |    | CR10HI FABRIC |             |   |             |
| B           | R  | O  | Y  | LPK | LB          | W  | O             | Y           |   |             |
| W           |    |    |    |     |             |    |               |             |   |             |

OPTIONAL

SHORT SLEEVED VERSION - CODE: **SSL**

|                  |                             |                  |
|------------------|-----------------------------|------------------|
| STANDING COLLAR  | CONDUCTIVE ELASTICATED CUFF | WAIST KNITTER    |
|                  |                             |                  |
| CODE: <b>AGL</b> | CODE: <b>RAN</b>            | CODE: <b>OTO</b> |

GROUNDING SMOCK - CODE: **GND/GNDR**



DEMO VIDEO



## ORDERING CODE SAMPLE

**ESX** - **TH55** - **RB** **L**  
 style fabric color size



You can contact us too for customized embroidered or screen printed company logos, lettering, custom designed ESD clothing.

DETAILS ON PAGE 113

Clothing certified according to the international ESD standards, as indicated by this/similar label



| SIZE CHART (CM) | XS | S  | M   | L   | XL  | XXL | 3XL | 4XL | 5XL |
|-----------------|----|----|-----|-----|-----|-----|-----|-----|-----|
| Cuff            | 32 | 33 | 34  | 35  | 36  | 36  | 37  | 37  | 38  |
| Sleeve          | 57 | 59 | 63  | 67  | 71  | 71  | 73  | 73  | 74  |
| Length          | 58 | 60 | 62  | 64  | 68  | 70  | 72  | 74  | 76  |
| Chest           | 90 | 98 | 106 | 114 | 122 | 130 | 136 | 142 | 148 |
| Hip             | 90 | 98 | 106 | 114 | 122 | 130 | 136 | 142 | 148 |
| Shoulder        | 36 | 39 | 42  | 45  | 48  | 51  | 54  | 57  | 60  |

Size tolerance (before washing): 2%

# EFX ESD SMOCK

1/3 LENGTH

## FEATURES

- » Standard sizes: Female XS - 5XL
- » 2 side pockets, 1 breast pocket with ESD logo
- » Hidden snap-fasteners
- » Cuff with snap-fasteners\*

## STANDARD FABRICS AND COLORS

**KK01 FABRIC**      **TH55 FABRIC**      **CT35 FABRIC**      **TH65 FABRIC**

BK DZ DG GA LG RB LB GA W W W

NB RB LB MG LE CR10 FABRIC CR10HI FABRIC

B R O Y LPK LB W O Y

W

You can contact us too for customized embroidered or screen printed company logos, lettering, custom designed ESD clothing.



## ORDERING CODE SAMPLE

**EFX** - **KK01** - **LE L** + **DLB** - **RAN** - **W**  
 style fabric color size option color

DETAILS ON PAGE 113

| SIZE CHART (CM) | XS | S  | M   | L   | XL  | XXL | 3XL | 4XL | 5XL |
|-----------------|----|----|-----|-----|-----|-----|-----|-----|-----|
| Cuff            | 32 | 33 | 34  | 35  | 36  | 36  | 37  | 37  | 38  |
| Sleeve          | 57 | 59 | 63  | 67  | 71  | 71  | 73  | 73  | 74  |
| Length          | 58 | 60 | 62  | 64  | 68  | 70  | 72  | 74  | 76  |
| Chest           | 90 | 98 | 106 | 114 | 122 | 130 | 136 | 142 | 148 |
| Hip             | 90 | 98 | 106 | 114 | 122 | 130 | 136 | 142 | 148 |
| Shoulder        | 36 | 39 | 42  | 45  | 48  | 51  | 54  | 57  | 60  |

Size tolerance (before washing): 2%



Clothing certified according to the international ESD standards, as indicated by this/similar label

DEMO VIDEO



\*The picture is with conductive elasticated cuff, which is optional, not standard design

# ET ESD MALE TROUSERS



## FEATURES

- » Standard sizes: Male XS - 5XL
- » Straight cut
- » 2 side pockets, 2 additional pockets on the legs, 1 hip pocket with ESD logo
- » Rubberized waist with snap-fastener

## STANDARD FABRICS AND COLORS

| KK01 FABRIC |    |    |    |     | TH55 FABRIC |    |               | CT35 FABRIC |             | TH65 FABRIC |
|-------------|----|----|----|-----|-------------|----|---------------|-------------|-------------|-------------|
| BK          | DZ | DG | GA | LG  | RB          | LB | GA            | W           | W           | W           |
| NB          | RB | LB | MG | LE  | CR10 FABRIC |    | CR10HI FABRIC |             | MC24 FABRIC |             |
| B           | R  | O  | Y  | LPK | LB          | W  | O             | Y           | DG          |             |
| W           |    |    |    |     |             |    |               |             |             |             |

## DEMO VIDEO



## ORDERING CODE SAMPLE

**ET** - **KK01** - **DG** **L**  
 style fabric color size



You can contact us too for customized embroidered or screen printed company logos, lettering, custom designed ESD clothing.

Clothing certified according to the international ESD standards, as indicated by this/similar label

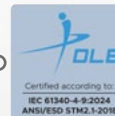

| SIZE CHART (CM) | XS  | S   | M   | L   | XL  | XXL | 3XL | 4XL | 5XL |
|-----------------|-----|-----|-----|-----|-----|-----|-----|-----|-----|
| Length external | 102 | 104 | 106 | 108 | 110 | 112 | 114 | 116 | 118 |
| Hip             | 98  | 102 | 107 | 111 | 115 | 119 | 123 | 128 | 132 |

DETAILS ON PAGE 113

Size tolerance (before washing): 2%



# ETF ESD FEMALE TROUSERS

## FEATURES

- » Standard sizes: Female XS - 5XL
- » Straight cut
- » 2 side pockets, 2 additional pockets on the legs, 1 hip pocket with ESD logo
- » Rubberized waist with snap-fastener

## STANDARD FABRICS AND COLORS

|             |    |    |    |     |             |    |               |   |             |  |             |   |
|-------------|----|----|----|-----|-------------|----|---------------|---|-------------|--|-------------|---|
| KK01 FABRIC |    |    |    |     | TH55 FABRIC |    |               |   | CT35 FABRIC |  | TH65 FABRIC |   |
| BK          | DZ | DG | GA | LG  | RB          | LB | GA            | W | W           |  |             | W |
| NB          | RB | LB | MG | LE  | CR10 FABRIC |    | CR10HI FABRIC |   | MC24 FABRIC |  |             |   |
| B           | R  | O  | Y  | LPK | LB          | W  | O             | Y | DG          |  |             |   |
| W           |    |    |    |     |             |    |               |   |             |  |             |   |



You can contact us too for customized embroidered or screen printed company logos, lettering, custom designed ESD clothing.

## ORDERING CODE SAMPLE

**ETF** - **KK01** - **DG** **L**  
 style fabric color size

## DEMO VIDEO



### DETAILS ON PAGE 113

| SIZE CHART (CM) | XS  | S   | M   | L   | XL  | XXL | 3XL | 4XL | 5XL |
|-----------------|-----|-----|-----|-----|-----|-----|-----|-----|-----|
| Length external | 102 | 104 | 106 | 108 | 110 | 112 | 114 | 116 | 118 |
| Hip             | 84  | 90  | 96  | 102 | 108 | 114 | 120 | 126 | 132 |

Size tolerance (before washing): 2%



Clothing certified according to the international ESD standards, as indicated by this/similar label

# OT ESD TROUSERS WITH BRIDLES



## FEATURES

- » Standard sizes: Unisex XS - 5XL
- » 2 side pockets, 1 front pocket with ESD logo
- » 2 side pockets on the legs
- » 2 quick release buckles

## STANDARD FABRICS AND COLORS

| KK01 FABRIC |    |    |    |     | TH55 FABRIC |    |               | CT35 FABRIC |             | TH65 FABRIC |
|-------------|----|----|----|-----|-------------|----|---------------|-------------|-------------|-------------|
| BK          | DZ | DG | GA | LG  | RB          | LB | GA            | W           | W           | W           |
| NB          | RB | LB | MG | LE  | CR10 FABRIC |    | CR10HI FABRIC |             | MC24 FABRIC |             |
| B           | R  | O  | Y  | LPK | LB          | W  | O             | Y           | DG          |             |
| W           |    |    |    |     |             |    |               |             |             |             |

## DEMO VIDEO



## ORDERING CODE SAMPLE

**OT** - **KK01** - **RB** **L**  
 style fabric color size



You can contact us too for customized embroidered or screen printed company logos, lettering, custom designed ESD clothing.

Clothing certified according to the international ESD standards, as indicated by this/similar label



| DETAILS ON PAGE 113 |     |     |     |     |     |     |     |     |     |  |
|---------------------|-----|-----|-----|-----|-----|-----|-----|-----|-----|--|
| SIZE CHART (CM)     | XS  | S   | M   | L   | XL  | XXL | 3XL | 4XL | 5XL |  |
| Length external     | 102 | 104 | 106 | 108 | 110 | 112 | 114 | 116 | 118 |  |
| Hip                 | 98  | 102 | 107 | 111 | 115 | 119 | 123 | 128 | 132 |  |

Size tolerance (before washing): 2%

# OJ ESD JACKET

## FEATURES

- » Standard sizes: Unisex XS - 5XL
- » 2 side pockets, 2 breast pockets
- » ESD logo on chest pocket
- » Hidden zipper
- » Rubberized cuff

## STANDARD FABRICS AND COLORS

|                    |    |    |    |     |                    |    |    |                      |    |                    |                    |   |                    |   |  |
|--------------------|----|----|----|-----|--------------------|----|----|----------------------|----|--------------------|--------------------|---|--------------------|---|--|
| <b>KK01 FABRIC</b> |    |    |    |     | <b>TH55 FABRIC</b> |    |    |                      |    | <b>CT35 FABRIC</b> |                    |   | <b>TH65 FABRIC</b> |   |  |
| BK                 | DZ | DG | GA | LG  | RB                 | LB | GA | W                    | W  | W                  | W                  | W | W                  | W |  |
| NB                 | RB | LB | MG | LE  | <b>CR10 FABRIC</b> |    |    | <b>CR10HI FABRIC</b> |    |                    | <b>MC24 FABRIC</b> |   |                    |   |  |
| B                  | R  | O  | Y  | LPK | LB                 | W  | O  | Y                    | DG |                    |                    |   |                    |   |  |
| W                  |    |    |    |     |                    |    |    |                      |    |                    |                    |   |                    |   |  |



You can contact us too for customized embroidered or screen printed company logos, lettering, custom designed ESD clothing.

## ORDERING CODE SAMPLE

**OJ - KK01 - RB L**  
 style fabric color size

## DEMO VIDEO



### DETAILS ON PAGE 113

| SIZE CHART (CM)               | XS | S  | M   | L   | XL  | XXL | 3XL | 4XL | 5XL |
|-------------------------------|----|----|-----|-----|-----|-----|-----|-----|-----|
| Sleeve                        | 61 | 63 | 67  | 71  | 75  | 76  | 77  | 77  | 78  |
| Length                        | 63 | 65 | 67  | 69  | 71  | 73  | 75  | 76  | 77  |
| Chest                         | 90 | 98 | 106 | 114 | 122 | 130 | 136 | 142 | 148 |
| Shoulder                      | 40 | 43 | 46  | 49  | 52  | 55  | 58  | 61  | 65  |
| Shoulder-sleeve circumference | 56 | 58 | 60  | 62  | 64  | 66  | 68  | 70  | 72  |

Size tolerance (before washing): 2%



Clothing certified according to the international ESD standards, as indicated by this/similar label

# HIV ESD HIGH VISIBILITY VEST

## FEATURES

- » Standard sizes: Unisex S-5XL
- » With reflective stripes
- » ESD logo on the chest area
- » Hidden snap-fasteners

## STANDARD FABRICS AND COLORS

### CR10HI FABRIC



Not an occupational safety product



You can contact us too for customized embroidered or screen printed company logos, lettering, custom designed ESD clothing.

## ORDERING CODE SAMPLE

**HIV** - **CR10HI** - **O** **L**  
 style fabric color size

### DEMO VIDEO



Clothing certified according to the international ESD standards, as indicated by this/similar label



**DETAILS ON PAGE 113**

| SIZE CHART (CM) | XS  | S   | M   | L   | XL  | XXL | 3XL | 4XL | 5XL |
|-----------------|-----|-----|-----|-----|-----|-----|-----|-----|-----|
| Chest           | 114 | 118 | 122 | 126 | 130 | 134 | 138 | 142 | 118 |
| Length          | 61  | 63  | 65  | 67  | 69  | 71  | 73  | 75  | 132 |

Size tolerance (before washing): 2%

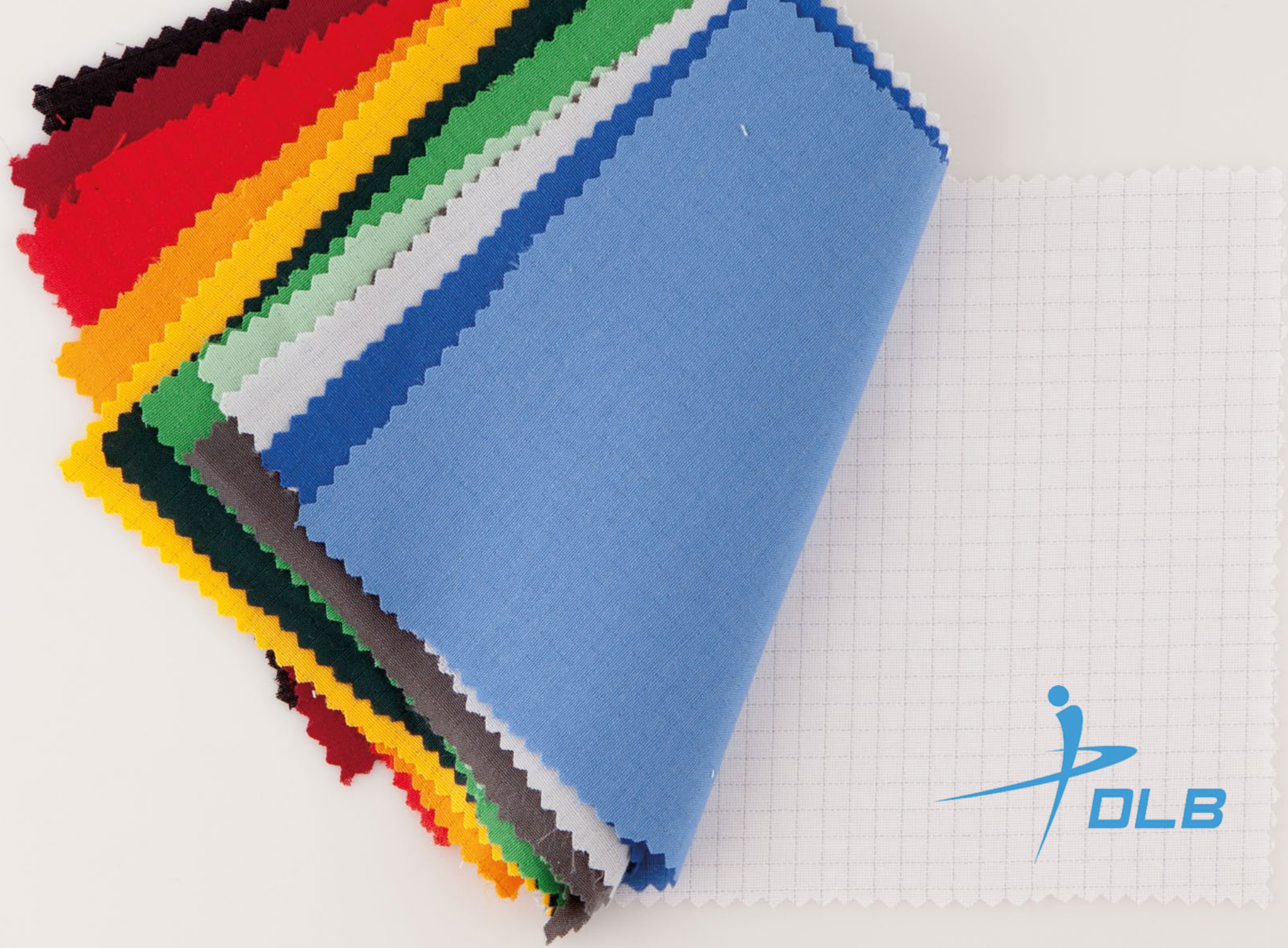

# KOT ESD TABARD



## FEATURES

- » Standard sizes: XS - 5XL
- » ESD logo on pocket
- » 1 pocket
- » Adjustable side straps with snap fasteners
- » Pullover type

## STANDARD FABRICS AND COLORS

| KK01 FABRIC |    |    |    |     | TH55 FABRIC |    |    | CT35 FABRIC   |   | TH65 FABRIC |
|-------------|----|----|----|-----|-------------|----|----|---------------|---|-------------|
| BK          | DZ | DG | GA | LG  | RB          | LB | GA | W             | W | W           |
| NB          | RB | LB | MG | LE  | CR10 FABRIC |    |    | CR10HI FABRIC |   |             |
| B           | R  | O  | Y  | LPK | LB          | W  | O  | Y             |   |             |
| W           |    |    |    |     |             |    |    |               |   |             |

VIDEO / WEBPAGE



## ORDERING CODE SAMPLE

**KOT** - **KK01** - **BK** **L**  
 style fabric color size



You can contact us too for customized embroidered or screen printed company logos, lettering, custom designed ESD clothing.

Clothing certified according to the international ESD standards, as indicated by this/similar label



| SIZE CHART (CM) | XS | S  | M  | L  | XL | XXL | 3XL | 4XL | 5XL |
|-----------------|----|----|----|----|----|-----|-----|-----|-----|
| Length          | 76 | 78 | 80 | 82 | 84 | 86  | 88  | 90  | 92  |

Size tolerance (before washing): 2%

# APR ESD APRON

## FEATURES

- » Unisex, one size
- » ESD logo on the chest area

## STANDARD FABRICS AND COLORS

|                    |    |    |    |     |                    |    |                      |   |                    |   |                    |  |
|--------------------|----|----|----|-----|--------------------|----|----------------------|---|--------------------|---|--------------------|--|
| <b>KK01 FABRIC</b> |    |    |    |     | <b>TH55 FABRIC</b> |    |                      |   | <b>CT35 FABRIC</b> |   | <b>TH65 FABRIC</b> |  |
| BK                 | DZ | DG | GA | LG  | RB                 | LB | GA                   | W | W                  | W |                    |  |
| NB                 | RB | LB | MG | LE  | <b>CR10 FABRIC</b> |    | <b>CR10HI FABRIC</b> |   |                    |   |                    |  |
| B                  | R  | O  | Y  | LPK | LB                 | W  | O                    | Y |                    |   |                    |  |
| W                  |    |    |    |     |                    |    |                      |   |                    |   |                    |  |



## ORDERING CODE SAMPLE

**APR - KK01 - BK**  
 style fabric color

## VIDEO / WEBPAGE



You can contact us too for customized embroidered or screen printed company logos, lettering, custom designed ESD clothing.



Clothing certified according to the international ESD standards, as indicated by this/similar label

# BB ESD BASEBALL STYLE CAP



## FEATURES

- » Unisex, one size
- » Sun visor
- » ESD logo
- » Rubberized back

## STANDARD FABRICS AND COLORS

| KK01 FABRIC |    |    |    |     | TH55 FABRIC |    |    | CT35 FABRIC   |   | TH65 FABRIC |
|-------------|----|----|----|-----|-------------|----|----|---------------|---|-------------|
| BK          | DZ | DG | GA | LG  | RB          | LB | GA | W             | W | W           |
| NB          | RB | LB | MG | LE  | CR10 FABRIC |    |    | CR10HI FABRIC |   |             |
| B           | R  | O  | Y  | LPK | LB          | W  | O  | Y             |   |             |
| W           |    |    |    |     |             |    |    |               |   |             |

## ORDERING CODE SAMPLE

**BB** - **KK01** - **DG**  
 style fabric color



You can contact us too for customized embroidered or screen printed company logos, lettering, custom designed ESD clothing.

Clothing certified according to the international ESD standards, as indicated by this/similar label



## DEMO VIDEO





# BP ESD CAP WITH NET

## FEATURES

- » Unisex, one size
- » Breathable net on the top of the cap
- » ESD logo
- » Plastic size adjuster on the back

## STANDARD FABRICS AND COLORS

|             |    |    |    |     |             |    |               |   |             |   |             |
|-------------|----|----|----|-----|-------------|----|---------------|---|-------------|---|-------------|
| KK01 FABRIC |    |    |    |     | TH55 FABRIC |    |               |   | CT35 FABRIC |   | TH65 FABRIC |
| BK          | DZ | DG | GA | LG  | RB          | LB | GA            | W | W           | W | W           |
| NB          | RB | LB | MG | LE  | CR10 FABRIC |    | CR10HI FABRIC |   |             |   |             |
| B           | R  | O  | Y  | LPK | LB          | W  | O             | Y |             |   |             |
| W           |    |    |    |     |             |    |               |   |             |   |             |



You can contact us too for customized embroidered or screen printed company logos, lettering, custom designed ESD clothing.

## ORDERING CODE SAMPLE

**BP** - **KK01** - **LPK**  
 style fabric color



## DEMO VIDEO



Clothing certified according to the international ESD standards, as indicated by this/similar label



# PREMIUM LINE

---

CLOTHING STYLES



42

**PF1 ESD PREMIUM SMOCK**

2/3 LENGTH



43

**PS1 ESD PREMIUM SMOCK**

2/3 LENGTH



44

**PF2 ESD PREMIUM SMOCK**

2/3 LENGTH



45

**PS2 ESD PREMIUM SMOCK**

2/3 LENGTH



46

**PF3 ESD PREMIUM SMOCK**

2/3 LENGTH

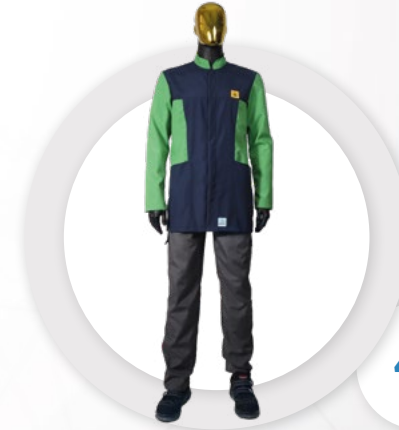

47

**PS3 ESD PREMIUM SMOCK**

2/3 LENGTH

# PF1 ESD PREMIUM SMOCK

2/3 LENGTH

## FEATURES

- » Standard sizes: Female XS - 5XL
- » 2 side pockets
- » Hidden snap-fasteners
- » Cuff with snap-fasteners
- » ESD logo on the chest area

## STANDARD FABRICS AND COLORS

### KK01 FABRIC

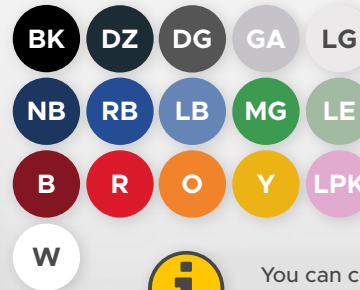

### TH55 FABRIC



CHOOSE THE MOST MATCHING COLOUR COMBINATION THAT SUITS YOUR COMPANY



You can contact us too for customized embroidered or screen printed company logos, lettering, custom designed ESD clothing.

## ORDERING CODE SAMPLE

**PF1 - KK01 - Y - DG L**  
 style fabric color1 color2 size



DEMO VIDEO



Clothing certified according to the international ESD standards, as indicated by this/similar label



DETAILS ON PAGE 113

| SIZE CHART (CM) | XS | S  | M   | L   | XL  | XXL | 3XL | 4XL | 5XL |
|-----------------|----|----|-----|-----|-----|-----|-----|-----|-----|
| Cuff            | 32 | 33 | 34  | 35  | 36  | 36  | 37  | 37  | 38  |
| Sleeve          | 57 | 59 | 63  | 67  | 71  | 71  | 73  | 73  | 74  |
| Length          | 89 | 91 | 93  | 95  | 99  | 101 | 103 | 105 | 107 |
| Chest           | 90 | 98 | 106 | 114 | 122 | 130 | 136 | 142 | 148 |
| Hip             | 90 | 98 | 106 | 114 | 122 | 130 | 136 | 142 | 148 |
| Shoulder        | 36 | 39 | 42  | 45  | 48  | 51  | 54  | 57  | 60  |

Size tolerance (before washing): 2%

DESIGNED BY *Zsófia Gáspár*

# PS1 ESD PREMIUM SMOCK

## OPTIONAL

GROUNDING SMOCK - CODE: GND/GNDR



## 2/3 LENGTH FEATURES

- » Standard sizes: Male XS - 5XL
- » 2 side pockets, 1 hidden breast pocket
- » Hidden snap-fasteners
- » Cuff with snap-fasteners
- » ESD logo on the chest area

## STANDARD FABRICS AND COLORS

### TH55 FABRIC



### KK01 FABRIC

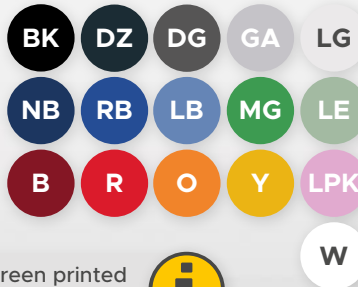

CHOOSE THE MOST MATCHING COLOUR COMBINATION THAT SUITS YOUR COMPANY



You can contact us too for customized embroidered or screen printed company logos, lettering, custom designed ESD clothing.



## ORDERING CODE SAMPLE

**PS1** - **KK01** - **O** - **RB** **L**  
 style fabric color1 color2 size

## DEMO VIDEO



DETAILS ON PAGE 113

| SIZE CHART (CM) | XS | S  | M   | L   | XL  | XXL | 3XL | 4XL | 5XL |
|-----------------|----|----|-----|-----|-----|-----|-----|-----|-----|
| Cuff            | 32 | 33 | 34  | 35  | 36  | 36  | 37  | 37  | 38  |
| Sleeve          | 57 | 59 | 63  | 67  | 71  | 71  | 73  | 73  | 74  |
| Length          | 89 | 91 | 93  | 95  | 99  | 101 | 103 | 105 | 107 |
| Chest           | 90 | 98 | 106 | 114 | 122 | 130 | 136 | 142 | 148 |
| Hip             | 90 | 98 | 106 | 114 | 122 | 130 | 136 | 142 | 148 |
| Shoulder        | 36 | 39 | 42  | 45  | 48  | 51  | 54  | 57  | 60  |

Size tolerance (before washing): 2%



Clothing certified according to the international ESD standards, as indicated by this/similar label

DESIGNED BY *Zsófia Gáspár*

# PF2 ESD PREMIUM SMOCK



2/3 LENGTH

## FEATURES

- » Standard sizes: Female XS - 5XL
- » 2 side pockets
- » Hidden snap-fasteners
- » Rubberized cuff
- » ESD logo on the chest area

## STANDARD FABRICS AND COLORS

### KK01 FABRIC

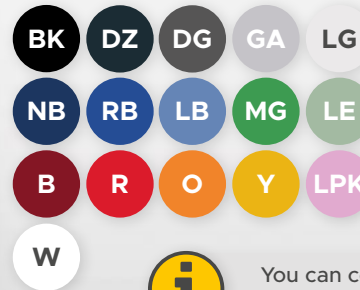

### TH55 FABRIC



CHOOSE THE MOST MATCHING COLOUR COMBINATION THAT SUITS YOUR COMPANY



You can contact us too for customized embroidered or screen printed company logos, lettering, custom designed ESD clothing.

## DEMO VIDEO



## ORDERING CODE SAMPLE

**PF2** - **KK01** - **W** - **B** **L**  
 style fabric color1 color2 size

DETAILS ON PAGE 113

Clothing certified according to the international ESD standards, as indicated by this/similar label

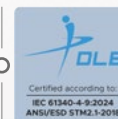

| SIZE CHART (CM) | XS | S  | M   | L   | XL  | XXL | 3XL | 4XL | 5XL |
|-----------------|----|----|-----|-----|-----|-----|-----|-----|-----|
| Cuff            | 32 | 33 | 34  | 35  | 36  | 36  | 37  | 37  | 38  |
| Sleeve          | 57 | 59 | 63  | 67  | 71  | 71  | 73  | 73  | 74  |
| Length          | 89 | 91 | 93  | 95  | 99  | 101 | 103 | 105 | 107 |
| Chest           | 90 | 98 | 106 | 114 | 122 | 130 | 136 | 142 | 148 |
| Hip             | 90 | 98 | 106 | 114 | 122 | 130 | 136 | 142 | 148 |
| Shoulder        | 36 | 39 | 42  | 45  | 48  | 51  | 54  | 57  | 60  |

Size tolerance (before washing): 2%

DESIGNED BY *Andrea Vandornyzik*

# PS2 ESD PREMIUM SMOCK

2/3 LENGTH

## OPTIONAL

GROUNDING SMOCK - CODE: GND/GNDR



## FEATURES

- » Standard sizes: Male XS - 5XL
- » 2 side pockets
- » Hidden snap-fasteners
- » Rubberized cuff
- » ESD logo on the chest area

## STANDARD FABRICS AND COLORS

### TH55 FABRIC



### KK01 FABRIC

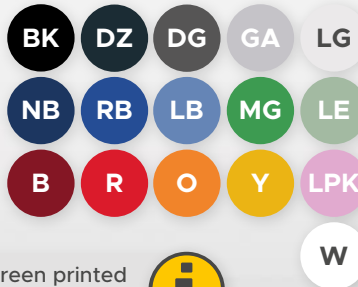

CHOOSE THE MOST MATCHING COLOUR COMBINATION THAT SUITS YOUR COMPANY



You can contact us too for customized embroidered or screen printed company logos, lettering, custom designed ESD clothing.



## ORDERING CODE SAMPLE

**PS2** - **KK01** - **W** - **DZ** **L**  
 style fabric color1 color2 size

DEMO VIDEO



DETAILS ON PAGE 113

| SIZE CHART (CM) | XS | S  | M   | L   | XL  | XXL | 3XL | 4XL | 5XL |
|-----------------|----|----|-----|-----|-----|-----|-----|-----|-----|
| Cuff            | 32 | 33 | 34  | 35  | 36  | 36  | 37  | 37  | 38  |
| Sleeve          | 57 | 59 | 63  | 67  | 71  | 71  | 73  | 73  | 74  |
| Length          | 89 | 91 | 93  | 95  | 99  | 101 | 103 | 105 | 107 |
| Chest           | 90 | 98 | 106 | 114 | 122 | 130 | 136 | 142 | 148 |
| Hip             | 90 | 98 | 106 | 114 | 122 | 130 | 136 | 142 | 148 |
| Shoulder        | 36 | 39 | 42  | 45  | 48  | 51  | 54  | 57  | 60  |

Size tolerance (before washing): 2%



Clothing certified according to the international ESD standards, as indicated by this/similar label



DESIGNED BY *Andrea Vandornyzik*

# PF3 ESD PREMIUM SMOCK

2/3 LENGTH

## FEATURES

- » Standard sizes: Female XS - 5XL
- » 2 side pockets
- » Hidden snap-fasteners
- » Cuff with snap-fasteners
- » ESD logo on the chest area

## STANDARD FABRICS AND COLORS

### KK01 FABRIC

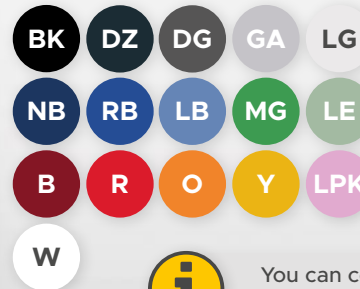

### TH55 FABRIC



CHOOSE THE MOST MATCHING COLOUR COMBINATION THAT SUITS YOUR COMPANY



You can contact us too for customized embroidered or screen printed company logos, lettering, custom designed ESD clothing.

## ORDERING CODE SAMPLE

**PF3** - **KK01** - **B** - **Y** **L**  
 style fabric color1 color2 size



### DEMO VIDEO



Clothing certified according to the international ESD standards, as indicated by this/similar label



DETAILS ON PAGE 113

| SIZE CHART (CM) | XS | S  | M   | L   | XL  | XXL | 3XL | 4XL | 5XL |
|-----------------|----|----|-----|-----|-----|-----|-----|-----|-----|
| Cuff            | 32 | 33 | 34  | 35  | 36  | 36  | 37  | 37  | 38  |
| Sleeve          | 57 | 59 | 63  | 67  | 71  | 71  | 73  | 73  | 74  |
| Length          | 89 | 91 | 93  | 95  | 99  | 101 | 103 | 105 | 107 |
| Chest           | 90 | 98 | 106 | 114 | 122 | 130 | 136 | 142 | 148 |
| Hip             | 90 | 98 | 106 | 114 | 122 | 130 | 136 | 142 | 148 |
| Shoulder        | 36 | 39 | 42  | 45  | 48  | 51  | 54  | 57  | 60  |

Size tolerance (before washing): 2%

DESIGNED BY *Barbala Kovacs*



# PS3 ESD PREMIUM SMOCK

2/3 LENGTH 

## OPTIONAL

GROUNDING SMOCK - CODE: GND/GNDR



## FEATURES

- » Standard sizes: Male XS - 5XL
- » 2 side pockets
- » Hidden snap-fasteners
- » Cuff with snap-fasteners
- » ESD logo on the chest area

## STANDARD FABRICS AND COLORS

### TH55 FABRIC



### KK01 FABRIC

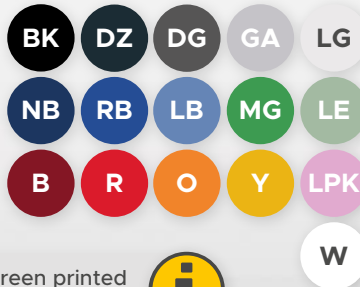

CHOOSE THE MOST MATCHING COLOUR COMBINATION THAT SUITS YOUR COMPANY 

You can contact us too for customized embroidered or screen printed company logos, lettering, custom designed ESD clothing.



## ORDERING CODE SAMPLE

**PS3 - KK01 - NB - MG L**  
 style fabric color1 color2 size

DEMO VIDEO 



DESIGNED BY *Barbala Kovacs*

DETAILS ON PAGE 113

| SIZE CHART (CM) | XS | S  | M   | L   | XL  | XXL | 3XL | 4XL | 5XL |
|-----------------|----|----|-----|-----|-----|-----|-----|-----|-----|
| Cuff            | 32 | 33 | 34  | 35  | 36  | 36  | 37  | 37  | 38  |
| Sleeve          | 57 | 59 | 63  | 67  | 71  | 71  | 73  | 73  | 74  |
| Length          | 89 | 91 | 93  | 95  | 99  | 101 | 103 | 105 | 107 |
| Chest           | 90 | 98 | 106 | 114 | 122 | 130 | 136 | 142 | 148 |
| Hip             | 90 | 98 | 106 | 114 | 122 | 130 | 136 | 142 | 148 |
| Shoulder        | 36 | 39 | 42  | 45  | 48  | 51  | 54  | 57  | 60  |

Size tolerance (before washing): 2%



Clothing certified according to the international ESD standards, as indicated by this/similar label



# BUSINESS LINE

---

CLOTHING STYLES



50

ING ESD MALE BUSINESS SHIRT

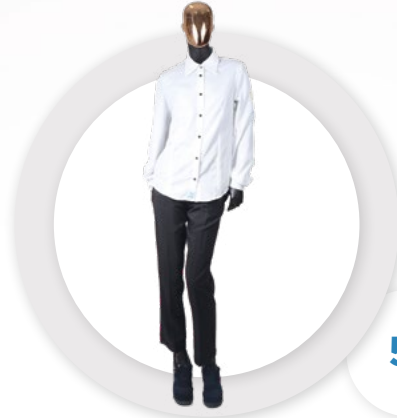

51

IFG ESD FEMALE BUSINESS SHIRT



52

NT ESD MALE SUITE PANTS



53

NTF ESD FEMALE SUITE PANTS

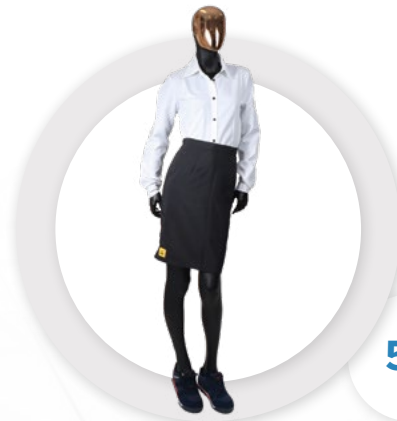

54

SKI ESD SKIRT

# ING ESD MALE BUSINESS SHIRT



## FEATURES

- » Standard sizes: Male XS - 5XL
- » Business style
- » 1 breast pocket
- » ESD logo on sleeve
- » Buttons

## STANDARD FABRICS AND COLORS

|             |    |    |    |     |             |    |    |   |             |  |
|-------------|----|----|----|-----|-------------|----|----|---|-------------|--|
| KK01 FABRIC |    |    |    |     | TH55 FABRIC |    |    |   | TH65 FABRIC |  |
| BK          | DZ | DG | GA | LG  | RB          | LB | GA | W | W           |  |
| NB          | RB | LB | MG | LE  | CT35 FABRIC |    |    |   |             |  |
| B           | R  | O  | Y  | LPK | W           |    |    |   |             |  |
| W           |    |    |    |     |             |    |    |   |             |  |

## DEMO VIDEO



## ORDERING CODE SAMPLE

**ING** - **KK01** - **W L**  
 style fabric color size



You can contact us too for customized embroidered or screen printed company logos, lettering, custom designed ESD clothing.

Clothing certified according to the international ESD standards, as indicated by this/similar label



## DETAILS ON PAGE 112

| SIZE CHART (CM) | XS | S   | M   | L   | XL  | XXL | 3XL | 4XL | 5XL |
|-----------------|----|-----|-----|-----|-----|-----|-----|-----|-----|
| Sleeve          | 56 | 58  | 60  | 62  | 64  | 66  | 68  | 70  | 70  |
| Length          | 66 | 68  | 70  | 72  | 74  | 76  | 78  | 80  | 80  |
| Chest           | 94 | 100 | 106 | 112 | 118 | 124 | 130 | 136 | 142 |
| Shoulder        | 39 | 41  | 43  | 45  | 47  | 49  | 51  | 54  | 57  |
| Cuff outline    | 23 | 24  | 25  | 26  | 27  | 28  | 29  | 30  | 31  |

Size tolerance (before washing): 2%

# IFG ESD FEMALE BUSINESS SHIRT

## FEATURES

- » Standard sizes: Female XS - 5XL
- » ESD logo on sleeve
- » Buttons

## STANDARD FABRICS AND COLORS

### TH65 FABRIC

W

### TH55 FABRIC

RB

LB

GA

W

### KK01 FABRIC

BK

DZ

DG

GA

LG

### CT35 FABRIC

W

NB

RB

LB

MG

LE

B

R

O

Y

LPK

W

## ORDERING CODE SAMPLE

**IFG** - **KK01** - **W** **L**  
 style fabric color size

## DEMO VIDEO



You can contact us too for customized embroidered or screen printed company logos, lettering, custom designed ESD clothing.



## DETAILS ON PAGE 112

| SIZE CHART (CM) | XS | S  | M  | L  | XL  | XXL | 3XL | 4XL | 5XL |
|-----------------|----|----|----|----|-----|-----|-----|-----|-----|
| Sleeve          | 56 | 58 | 60 | 62 | 64  | 66  | 68  | 70  | 70  |
| Length          | 56 | 58 | 60 | 62 | 64  | 66  | 68  | 70  | 70  |
| Chest           | 84 | 88 | 92 | 96 | 100 | 104 | 108 | 112 | 116 |
| Shoulder        | 40 | 40 | 42 | 44 | 46  | 48  | 50  | 52  | 54  |
| Cuff outline    | 21 | 22 | 23 | 24 | 25  | 26  | 27  | 28  | 29  |

Size tolerance (before washing): 2%



Clothing certified according to the international ESD standards, as indicated by this/similar label

# NT ESD MALE SUITE PANTS



## FEATURES

- » Standard sizes: Male XS - 5XL
- » Straight cut
- » 2 side pockets, 1 hip pocket
- » ESD logo on the waist

## STANDARD FABRICS AND COLORS

|             |    |    |    |     |             |    |    |   |             |  |
|-------------|----|----|----|-----|-------------|----|----|---|-------------|--|
| KK01 FABRIC |    |    |    |     | TH55 FABRIC |    |    |   | TH65 FABRIC |  |
| BK          | DZ | DG | GA | LG  | RB          | LB | GA | W | W           |  |
| NB          | RB | LB | MG | LE  | CT35 FABRIC |    |    |   |             |  |
| B           | R  | O  | Y  | LPK | W           |    |    |   |             |  |
| W           |    |    |    |     |             |    |    |   |             |  |

## DEMO VIDEO



## ORDERING CODE SAMPLE

**NT** - **KK01** - **BK** **L**  
 style fabric color size



You can contact us too for customized embroidered or screen printed company logos, lettering, custom designed ESD clothing.

Clothing certified according to the international ESD standards, as indicated by this/similar label



| DETAILS ON PAGE 113 |     |     |     |     |     |     |     |     |     |  |
|---------------------|-----|-----|-----|-----|-----|-----|-----|-----|-----|--|
| SIZE CHART (CM)     | XS  | S   | M   | L   | XL  | XXL | 3XL | 4XL | 5XL |  |
| Waist               | 80  | 84  | 88  | 92  | 96  | 100 | 104 | 109 | 113 |  |
| Hip                 | 98  | 102 | 107 | 111 | 115 | 119 | 123 | 128 | 132 |  |
| Length external     | 102 | 104 | 106 | 108 | 110 | 112 | 114 | 116 | 118 |  |

Size tolerance (before washing): 2%

# NTF ESD FEMALE SUITE PANTS

## FEATURES

- » Standard sizes: Female XS - 5XL
- » Straight cut
- » 2 side pockets
- » ESD logo on the waist

## STANDARD FABRICS AND COLORS

### TH65 FABRIC

W

### TH55 FABRIC

RB

LB

GA

W

### KK01 FABRIC

BK

DZ

DG

GA

LG

### CT35 FABRIC

W

NB

RB

LB

MG

LE

B

R

O

Y

LPK

W

## ORDERING CODE SAMPLE

**NTF** - **KK01** - **BK** **L**  
 style fabric color size

## DEMO VIDEO



You can contact us too for customized embroidered or screen printed company logos, lettering, custom designed ESD clothing.

### DETAILS ON PAGE 113

| SIZE CHART (CM) | XS  | S   | M   | L   | XL  | XXL | 3XL | 4XL | 5XL |
|-----------------|-----|-----|-----|-----|-----|-----|-----|-----|-----|
| Waist           | 68  | 72  | 76  | 80  | 84  | 88  | 92  | 97  | 101 |
| Hip             | 98  | 102 | 107 | 111 | 115 | 119 | 123 | 128 | 132 |
| Length external | 102 | 104 | 106 | 108 | 110 | 112 | 114 | 116 | 118 |

Size tolerance (before washing): 2%



Clothing certified according to the international ESD standards, as indicated by this/similar label

# SKI ESD SKIRT



## FEATURES

- » Standard sizes: XS – 5XL
- » Length: knee-high
- » Pencil style
- » With ESD logo

## STANDARD FABRICS AND COLORS

|             |    |    |    |     |             |    |    |   |             |  |
|-------------|----|----|----|-----|-------------|----|----|---|-------------|--|
| KK01 FABRIC |    |    |    |     | TH55 FABRIC |    |    |   | TH65 FABRIC |  |
| BK          | DZ | DG | GA | LG  | RB          | LB | GA | W | W           |  |
| NB          | RB | LB | MG | LE  | CT35 FABRIC |    |    |   |             |  |
| B           | R  | O  | Y  | LPK | W           |    |    |   |             |  |
| W           |    |    |    |     |             |    |    |   |             |  |

VIDEO / WEBPAGE



## ORDERING CODE SAMPLE

**SKI - KK01 - BK L**  
 style fabric color size



You can contact us too for customized embroidered or screen printed company logos, lettering, custom designed ESD clothing.

Clothing certified according to the international ESD standards, as indicated by this/similar label



DETAILS ON PAGE 113

| SIZE CHART (CM) | XS | S   | M   | L   | XL  | XXL | 3XL | 4XL | 5XL |
|-----------------|----|-----|-----|-----|-----|-----|-----|-----|-----|
| Waist           | 76 | 80  | 84  | 88  | 92  | 96  | 100 | 104 | 108 |
| Hip             | 98 | 102 | 106 | 110 | 114 | 118 | 122 | 126 | 130 |
| Length          | 59 | 61  | 63  | 65  | 67  | 69  | 71  | 71  | 71  |

Size tolerance (before washing): 2%





**+36 27 502 555**  
**SALES@DESTSA.HU**  
**WWW.DLB.HU**





# SUMMER LINE

---

CLOTHING STYLES



58

**TKO/F ESD T-SHIRT**

ROUND NECK, NO POCKET



59

**TKZ/F ESD T-SHIRT**

ROUND NECK, BREAST POCKET



60

**LKO/F ESD T-SHIRT**

ROUND NECK, NO POCKET



61

**LKZ/F ESD T-SHIRT**

ROUND NECK, BREAST POCKET



62

**TGO/F ESD T-SHIRT**

V-NECK, NO POCKET



63

**TGZ/F ESD T-SHIRT**

V-NECK, BREAST POCKET



64

**LGO/F ESD T-SHIRT**

V-NECK, NO POCKET



65

**LGZ/F ESD T-SHIRT**

V-NECK, BREAST POCKET



66

**PGO/F ESD POLO-SHIRT**

COLLAR, NO POCKET



67

**PGZ/F ESD POLO-SHIRT**

COLLAR, BREAST POCKET



68

**QGO/F ESD POLO-SHIRT**

COLLAR, NO POCKET



69

**QGZ/F ESD POLO-SHIRT**

COLLAR, BREAST POCKET



70

**TLY ESD STRETCH T-SHIRT**

ROUND NECK, NO POCKET

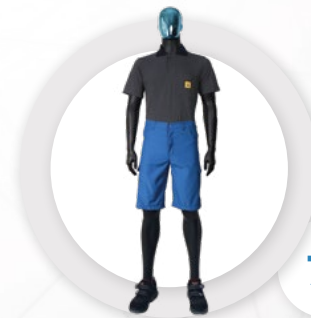

71

**RGA ESD SHORTS**

# TKO/F ESD T-SHIRT

SHORT SLEEVE, ROUND NECK, NO POCKET

## FEATURES

- » Standard sizes: Unisex XS - 5XL, female (F) XS - 5XL
- » **Female model:** Slim style
- » Round neck
- » Without any pocket
- » ESD logo on sleeve

## STANDARD FABRICS AND COLORS

### TS15 FABRIC



### PS21 FABRIC



### TS16 FABRIC



You can contact us too for customized embroidered or screen printed company logos, lettering, custom designed ESD clothing.



**The sizechart below shows the dimensions before washing.**  
After washing, it should be calculated with a shrinkage of 8-10% for width (mainly for breast size).

## ORDERING CODE SAMPLE

**TKOF** - **TS15** - **BK L**  
style female fabric color size

VIDEO / WEBPAGE



Clothing certified according to the international ESD standards, as indicated by this/similar label



The sizes given here meant values before washing.  
**DETAILS AND FEMALE SIZE CHART ON PAGE 112**

| SIZE CHART (CM) | XS   | S    | M    | L    | XL  | XXL  | 3XL | 4XL  | 5XL |
|-----------------|------|------|------|------|-----|------|-----|------|-----|
| Sleeve          | 20,5 | 21,5 | 22,5 | 23,5 | 25  | 26,5 | 28  | 29,5 | 31  |
| Length          | 63   | 66   | 69   | 72   | 75  | 78   | 81  | 84   | 87  |
| Chest           | 100  | 106  | 112  | 118  | 124 | 130  | 136 | 142  | 148 |
| Shoulder        | 41   | 43   | 45   | 47   | 49  | 51   | 54  | 57   | 60  |

Size tolerance (before washing): 2%

**!** We suggest to determine personal size with measurement on washed clothes.

# TKZ/F ESD T-SHIRT

SHORT SLEEVE, ROUND NECK, BREAST POCKET

## FEATURES

- » Standard sizes: Unisex XS - 5XL, female (F) XS - 5XL
- » Female model: Slim style
- » Round neck
- » Breast pocket with ESD logo

## STANDARD FABRICS AND COLORS

### TS15 FABRIC



### PS21 FABRIC



### TS16 FABRIC



You can contact us too for customized embroidered or screen printed company logos, lettering, custom designed ESD clothing.



The sizechart below shows the dimensions before washing.

After washing, it should be calculated with a shrinkage of 8-10% for width (mainly for breast size).



## ORDERING CODE SAMPLE

**TKZF** - **TS15** - **GA** **L**  
style female fabric color size

### VIDEO / WEBPAGE



The sizes given here meant values before washing.

DETAILS AND FEMALE SIZE CHART ON PAGE 112

| SIZE CHART (CM) | XS   | S    | M    | L    | XL  | XXL  | 3XL | 4XL  | 5XL |
|-----------------|------|------|------|------|-----|------|-----|------|-----|
| Sleeve          | 20,5 | 21,5 | 22,5 | 23,5 | 25  | 26,5 | 28  | 29,5 | 31  |
| Length          | 63   | 66   | 69   | 72   | 75  | 78   | 81  | 84   | 87  |
| Chest           | 100  | 106  | 112  | 118  | 124 | 130  | 136 | 142  | 148 |
| Shoulder        | 41   | 43   | 45   | 47   | 49  | 51   | 54  | 57   | 60  |



Clothing certified according to the international ESD standards, as indicated by this/similar label

Size tolerance (before washing): 2%

We suggest to determine personal size with measurement on washed clothes. 

# LKO/F ESD T-SHIRT

LONG SLEEVE, ROUND NECK, NO POCKET

## FEATURES

- » Standard sizes: Unisex XS - 5XL, female (F) XS - 5XL
- » **Female model:** Slim style
- » Round neck
- » Without any pocket
- » ESD logo on sleeve

## STANDARD FABRICS AND COLORS

### TS15 FABRIC



### PS21 FABRIC



### TS16 FABRIC



You can contact us too for customized embroidered or screen printed company logos, lettering, custom designed ESD clothing.



**The sizechart below shows the dimensions before washing.**  
After washing, it should be calculated with a shrinkage of 8-10% for width (mainly for breast size).

## ORDERING CODE SAMPLE

**LKOF - TS15 - BK L**  
style female fabric color size

VIDEO / WEBPAGE



Clothing certified according to the international ESD standards, as indicated by this/similar label



The sizes given here meant values before washing.  
**DETAILS AND FEMALE SIZE CHART ON PAGE 112**

| SIZE CHART (CM) | XS   | S   | M   | L   | XL  | XXL | 3XL | 4XL | 5XL |
|-----------------|------|-----|-----|-----|-----|-----|-----|-----|-----|
| Sleeve          | 51,5 | 53  | 57  | 61  | 63  | 65  | 67  | 67  | 68  |
| Length          | 63   | 66  | 69  | 72  | 75  | 78  | 81  | 84  | 87  |
| Chest           | 100  | 106 | 112 | 118 | 124 | 130 | 136 | 142 | 148 |
| Shoulder        | 41   | 43  | 45  | 47  | 49  | 51  | 54  | 57  | 60  |

Size tolerance (before washing): 2%

**!** We suggest to determine personal size with measurement on washed clothes.

# LKZ/F ESD T-SHIRT

LONG SLEEVE, ROUND NECK, BREAST POCKET

## FEATURES

- » Standard sizes: Unisex XS - 5XL, female (F) XS - 5XL
- » Female model: Slim style
- » Round neck
- » Breast pocket with ESD logo

## STANDARD FABRICS AND COLORS

### TS15 FABRIC



### PS21 FABRIC



### TS16 FABRIC



You can contact us too for customized embroidered or screen printed company logos, lettering, custom designed ESD clothing.



The sizechart below shows the dimensions before washing. After washing, it should be calculated with a shrinkage of 8-10% for width (mainly for breast size).



## ORDERING CODE SAMPLE

**LKZF** - **TS15** - **GA** **L**  
 style female fabric color size

### VIDEO / WEBPAGE



The sizes given here meant values before washing.

**DETAILS AND FEMALE SIZE CHART ON PAGE 112**

| SIZE CHART (CM) | XS   | S   | M   | L   | XL  | XXL | 3XL | 4XL | 5XL |
|-----------------|------|-----|-----|-----|-----|-----|-----|-----|-----|
| Sleeve          | 51,5 | 53  | 57  | 61  | 63  | 65  | 67  | 67  | 68  |
| Length          | 63   | 66  | 69  | 72  | 75  | 78  | 81  | 84  | 87  |
| Chest           | 100  | 106 | 112 | 118 | 124 | 130 | 136 | 142 | 148 |
| Shoulder        | 41   | 43  | 45  | 47  | 49  | 51  | 54  | 57  | 60  |



Clothing certified according to the international ESD standards, as indicated by this/similar label

Size tolerance (before washing): 2%

We suggest to determine personal size with measurement on washed clothes. 

# TGO/F ESD T-SHIRT

SHORT SLEEVE, V-NECK, NO POCKET

## FEATURES

- » Standard sizes: Unisex XS - 5XL, female (F) XS - 5XL
- » **Female model:** Slim style
- » V-neck
- » Without any pocket
- » ESD logo on sleeve

## STANDARD FABRICS AND COLORS

### TS15 FABRIC



### PS21 FABRIC



### TS16 FABRIC



You can contact us too for customized embroidered or screen printed company logos, lettering, custom designed ESD clothing.



**The sizechart below shows the dimensions before washing.**  
After washing, it should be calculated with a shrinkage of 8-10% for width (mainly for breast size).

## ORDERING CODE SAMPLE

**TGO****F** - **TS15** - **GR** **L**  
style female fabric color size

VIDEO / WEBPAGE



Clothing certified according to the international ESD standards, as indicated by this/similar label



| SIZE CHART (CM) | XS   | S    | M    | L    | XL  | XXL  | 3XL | 4XL  | 5XL |
|-----------------|------|------|------|------|-----|------|-----|------|-----|
| Sleeve          | 20,5 | 21,5 | 22,5 | 23,5 | 25  | 26,5 | 28  | 29,5 | 31  |
| Length          | 63   | 66   | 69   | 72   | 75  | 78   | 81  | 84   | 87  |
| Chest           | 100  | 106  | 112  | 118  | 124 | 130  | 136 | 142  | 148 |
| Shoulder        | 41   | 43   | 45   | 47   | 49  | 51   | 54  | 57   | 60  |

The sizes given here meant values before washing.  
**DETAILS AND FEMALE SIZE CHART ON PAGE 112**

Size tolerance (before washing): 2%

! We suggest to determine personal size with measurement on washed clothes.



# TGZ/F ESD T-SHIRT

SHORT SLEEVE, V-NECK, BREAST POCKET

## FEATURES

- » Standard sizes: Unisex XS - 5XL, female (F) XS - 5XL
- » Female model: Slim style
- » V-neck
- » Breast pocket with ESD logo

## STANDARD FABRICS AND COLORS

### TS15 FABRIC



### PS21 FABRIC



### TS16 FABRIC



You can contact us too for customized embroidered or screen printed company logos, lettering, custom designed ESD clothing.



The sizechart below shows the dimensions before washing.

After washing, it should be calculated with a shrinkage of 8-10% for width (mainly for breast size).



## ORDERING CODE SAMPLE

**TGZF - TS15 - NB L**  
 style female fabric color size

### VIDEO / WEBPAGE



The sizes given here meant values before washing.

DETAILS AND FEMALE SIZE CHART ON PAGE 112

| SIZE CHART (CM) | XS   | S    | M    | L    | XL  | XXL  | 3XL | 4XL  | 5XL |
|-----------------|------|------|------|------|-----|------|-----|------|-----|
| Sleeve          | 20,5 | 21,5 | 22,5 | 23,5 | 25  | 26,5 | 28  | 29,5 | 31  |
| Length          | 63   | 66   | 69   | 72   | 75  | 78   | 81  | 84   | 87  |
| Chest           | 100  | 106  | 112  | 118  | 124 | 130  | 136 | 142  | 148 |
| Shoulder        | 41   | 43   | 45   | 47   | 49  | 51   | 54  | 57   | 60  |



Clothing certified according to the international ESD standards, as indicated by this/similar label

Size tolerance (before washing): 2%

We suggest to determine personal size with measurement on washed clothes. 

# LGO/F ESD T-SHIRT

LONG SLEEVE, V-NECK, NO POCKET

## FEATURES

- » Standard sizes: Unisex XS - 5XL, female (F) XS - 5XL
- » **Female model:** Slim style
- » V-neck
- » Without any pocket
- » ESD logo on sleeve

## STANDARD FABRICS AND COLORS

### TS15 FABRIC



### PS21 FABRIC



### TS16 FABRIC



You can contact us too for customized embroidered or screen printed company logos, lettering, custom designed ESD clothing.



**The sizechart below shows the dimensions before washing.**  
After washing, it should be calculated with a shrinkage of 8-10% for width (mainly for breast size).

## ORDERING CODE SAMPLE

**LGO****F** - **TS15** - **GR** **L**  
style female fabric color size

VIDEO / WEBPAGE



Clothing certified according to the international ESD standards, as indicated by this/similar label



The sizes given here meant values before washing.  
**DETAILS AND FEMALE SIZE CHART ON PAGE 112**

| SIZE CHART (CM) | XS   | S   | M   | L   | XL  | XXL | 3XL | 4XL | 5XL |
|-----------------|------|-----|-----|-----|-----|-----|-----|-----|-----|
| Sleeve          | 51,5 | 53  | 57  | 61  | 63  | 65  | 67  | 67  | 68  |
| Length          | 63   | 66  | 69  | 72  | 75  | 78  | 81  | 84  | 87  |
| Chest           | 100  | 106 | 112 | 118 | 124 | 130 | 136 | 142 | 148 |
| Shoulder        | 41   | 43  | 45  | 47  | 49  | 51  | 54  | 57  | 60  |

Size tolerance (before washing): 2%

**!** We suggest to determine personal size with measurement on washed clothes.

# LGZ/F ESD T-SHIRT

LONG SLEEVE, V-NECK, BREAST POCKET

## FEATURES

- » Standard sizes: Unisex XS - 5XL, female (F) XS - 5XL
- » Female model: Slim style
- » V-neck
- » Breast pocket with ESD logo

## STANDARD FABRICS AND COLORS

### TS15 FABRIC



### PS21 FABRIC



### TS16 FABRIC



You can contact us too for customized embroidered or screen printed company logos, lettering, custom designed ESD clothing.



The sizechart below shows the dimensions before washing.

After washing, it should be calculated with a shrinkage of 8-10% for width (mainly for breast size).



## ORDERING CODE SAMPLE

**LGZF** - **TS15** - **NB** **L**  
 style female fabric color size

### VIDEO / WEBPAGE



The sizes given here meant values before washing.

DETAILS AND FEMALE SIZE CHART ON PAGE 112

| SIZE CHART (CM) | XS   | S   | M   | L   | XL  | XXL | 3XL | 4XL | 5XL |
|-----------------|------|-----|-----|-----|-----|-----|-----|-----|-----|
| Sleeve          | 51,5 | 53  | 57  | 61  | 63  | 65  | 67  | 67  | 68  |
| Length          | 63   | 66  | 69  | 72  | 75  | 78  | 81  | 84  | 87  |
| Chest           | 100  | 106 | 112 | 118 | 124 | 130 | 136 | 142 | 148 |
| Shoulder        | 41   | 43  | 45  | 47  | 49  | 51  | 54  | 57  | 60  |



Clothing certified according to the international ESD standards, as indicated by this/similar label

Size tolerance (before washing): 2%

We suggest to determine personal size with measurement on washed clothes. 

# PGO/F ESD POLO-SHIRT

SHORT SLEEVE, COLLAR, NO POCKET

## FEATURES

- » Standard sizes: Unisex XS - 5XL, female (F) XS - 5XL
- » **Female model:** Slim style
- » Without any pocket
- » ESD logo on sleeve
- » Hidden snap-fasteners

## OPTIONAL

- + Collar from its own fabric  
**CODE: SAA**

## STANDARD FABRICS AND COLORS

### TS15 FABRIC



### PS21 FABRIC



### TS16 FABRIC



You can contact us too for customized embroidered or screen printed company logos, lettering, custom designed ESD clothing.



**The sizechart below shows the dimensions before washing.**  
After washing, it should be calculated with a shrinkage of 8-10% for width (mainly for breast size).

## ORDERING CODE SAMPLE

**PGOF - PS21 - NB L**  
style female fabric color size

VIDEO / WEBPAGE



Clothing certified according to the international ESD standards, as indicated by this/similar label



The sizes given here meant values before washing.  
**DETAILS AND FEMALE SIZE CHART ON PAGE 112**

| SIZE CHART (CM) | XS   | S    | M    | L    | XL  | XXL  | 3XL | 4XL  | 5XL |
|-----------------|------|------|------|------|-----|------|-----|------|-----|
| Sleeve          | 20,5 | 21,5 | 22,5 | 23,5 | 25  | 26,5 | 28  | 29,5 | 31  |
| Length          | 63   | 66   | 69   | 72   | 75  | 78   | 81  | 84   | 87  |
| Chest           | 100  | 106  | 112  | 118  | 124 | 130  | 136 | 142  | 148 |
| Shoulder        | 41   | 43   | 45   | 47   | 49  | 51   | 54  | 57   | 60  |

Size tolerance (before washing): 2%

**!** We suggest to determine personal size with measurement on washed clothes.

# PGZ/F ESD POLO-SHIRT

SHORT SLEEVE, COLLAR, BREAST POCKET

## OPTIONAL

- Collar from its own fabric  
**CODE: SAA**

## FEATURES

- » Standard sizes: Unisex XS - 5XL, female (F) XS - 5XL
- » Female model: Slim style
- » Breast pocket with ESD logo
- » Hidden snap-fasteners

## STANDARD FABRICS AND COLORS

### TS15 FABRIC



### PS21 FABRIC



### TS16 FABRIC



You can contact us too for customized embroidered or screen printed company logos, lettering, custom designed ESD clothing.



The sizechart below shows the dimensions before washing. After washing, it should be calculated with a shrinkage of 8-10% for width (mainly for breast size).



## ORDERING CODE SAMPLE

**PGZF - PS21 - RB L**  
style female fabric color size

VIDEO / WEBPAGE



The sizes given here meant values before washing.

**DETAILS AND FEMALE SIZE CHART ON PAGE 112**

| SIZE CHART (CM) | XS   | S    | M    | L    | XL  | XXL  | 3XL | 4XL  | 5XL |
|-----------------|------|------|------|------|-----|------|-----|------|-----|
| Sleeve          | 20,5 | 21,5 | 22,5 | 23,5 | 25  | 26,5 | 28  | 29,5 | 31  |
| Length          | 63   | 66   | 69   | 72   | 75  | 78   | 81  | 84   | 87  |
| Chest           | 100  | 106  | 112  | 118  | 124 | 130  | 136 | 142  | 148 |
| Shoulder        | 41   | 43   | 45   | 47   | 49  | 51   | 54  | 57   | 60  |



Clothing certified according to the international ESD standards, as indicated by this/similar label

Size tolerance (before washing): 2%

We suggest to determine personal size with measurement on washed clothes. 



# QGO/F ESD POLO-SHIRT

LONG SLEEVE, COLLAR, NO POCKET

## FEATURES

- » Standard sizes: Unisex XS - 5XL, female (F) XS - 5XL
- » **Female model:** Slim style
- » Without any pocket
- » ESD logo on sleeve
- » Hidden snap-fasteners

## OPTIONAL

- + Collar from its own fabric  
**CODE: SAA**

## STANDARD FABRICS AND COLORS

### TS15 FABRIC



### PS21 FABRIC



### TS16 FABRIC



You can contact us too for customized embroidered or screen printed company logos, lettering, custom designed ESD clothing.



**The sizechart below shows the dimensions before washing.**  
After washing, it should be calculated with a shrinkage of 8-10% for width (mainly for breast size).

## ORDERING CODE SAMPLE

**QGO**F - **PS21** - **NB** **L**  
style female fabric color size

VIDEO / WEBPAGE



Clothing certified according to the international ESD standards, as indicated by this/similar label



The sizes given here meant values before washing.  
**DETAILS AND FEMALE SIZE CHART ON PAGE 112**

| SIZE CHART (CM) | XS   | S   | M   | L   | XL  | XXL | 3XL | 4XL | 5XL |
|-----------------|------|-----|-----|-----|-----|-----|-----|-----|-----|
| Sleeve          | 51,5 | 53  | 57  | 61  | 63  | 65  | 67  | 67  | 68  |
| Length          | 63   | 66  | 69  | 72  | 75  | 78  | 81  | 84  | 87  |
| Chest           | 100  | 106 | 112 | 118 | 124 | 130 | 136 | 142 | 148 |
| Shoulder        | 41   | 43  | 45  | 47  | 49  | 51  | 54  | 57  | 60  |

Size tolerance (before washing): 2%

**!** We suggest to determine personal size with measurement on washed clothes.

# QGZ/F ESD POLO-SHIRT

LONG SLEEVE, COLLAR, BREAST POCKET

## OPTIONAL

- + Collar from its own fabric  
**CODE: SAA**

## FEATURES

- » Standard sizes: Unisex XS - 5XL, female (F) XS - 5XL
- » Female model: Slim style
- » Breast pocket with ESD logo
- » Hidden snap-fasteners

## STANDARD FABRICS AND COLORS

### TS15 FABRIC



### PS21 FABRIC



### TS16 FABRIC



You can contact us too for customized embroidered or screen printed company logos, lettering, custom designed ESD clothing.



The sizechart below shows the dimensions before washing. After washing, it should be calculated with a shrinkage of 8-10% for width (mainly for breast size).



## ORDERING CODE SAMPLE

**QGZF - PS21 - RB L**  
style female fabric color size

VIDEO / WEBPAGE



The sizes given here meant values before washing.

**DETAILS AND FEMALE SIZE CHART ON PAGE 112**

| SIZE CHART (CM) | XS   | S   | M   | L   | XL  | XXL | 3XL | 4XL | 5XL |
|-----------------|------|-----|-----|-----|-----|-----|-----|-----|-----|
| Sleeve          | 51,5 | 53  | 57  | 61  | 63  | 65  | 67  | 67  | 68  |
| Length          | 63   | 66  | 69  | 72  | 75  | 78  | 81  | 84  | 87  |
| Chest           | 100  | 106 | 112 | 118 | 124 | 130 | 136 | 142 | 148 |
| Shoulder        | 41   | 43  | 45  | 47  | 49  | 51  | 54  | 57  | 60  |



Clothing certified according to the international ESD standards, as indicated by this/similar label

Size tolerance (before washing): 2%

We suggest to determine personal size with measurement on washed clothes. 

# TLY ESD STRETCH T-SHIRT

SHORT SLEEVE, ROUND NECK, NO POCKET

## FEATURES

- » Standard sizes: Unisex XS - 5XL
- » Without any pocket
- » Slim style, stretch material
- » ESD logo on sleeve
- » Round neck
- » Comfortable, breathable
- » Short sleeve

## STANDARD FABRICS AND COLORS

### LY20 FABRIC

BK



You can contact us too for customized embroidered or screen printed company logos, lettering, custom designed ESD clothing.



**The sizechart below shows the dimensions before washing.**  
After washing, it should be calculated with a shrinkage of 8-10% for width (mainly for breast size).

## ORDERING CODE SAMPLE

**TLY - LY20 - BK L**  
style fabric color size

### DEMO VIDEO



Clothing certified according to the international ESD standards, as indicated by this/similar label



The sizes given here meant values before washing.  
**DETAILS AND FEMALE SIZE CHART ON PAGE 112**

| SIZE CHART (CM) | XS   | S    | M    | L    | XL   | XXL | 3XL  | 4XL | 5XL  |
|-----------------|------|------|------|------|------|-----|------|-----|------|
| Sleeve          | 19,5 | 20,5 | 21,5 | 22,5 | 23,5 | 25  | 26,5 | 28  | 29,5 |
| Length          | 56   | 59   | 62   | 65   | 68   | 71  | 74   | 77  | 80   |
| Chest           | 94   | 100  | 106  | 112  | 118  | 124 | 130  | 136 | 142  |
| Shoulder        | 39   | 41   | 43   | 45   | 47   | 49  | 51   | 54  | 57   |

Size tolerance (before washing): 2%

**!** We suggest to determine personal size with measurement on washed clothes.



# RG A ESD SHORTS

- » Standard sizes: Male XS - 5XL
- » Straight style
- » 2 side pockets, 1 hip pocket with ESD logo

- » 1 side pocket on the leg
- » 1 tool pocket on the leg
- » Rubberized waist with snap-fastener

## FEATURES

## STANDARD FABRICS AND COLORS

### TH65 FABRIC

W

### TH55 FABRIC

RB LB GA W

### CT35 FABRIC

W

### KK01 FABRIC

BK DZ DG GA LG

NB RB LB MG LE

B R O Y LPK

W

## ORDERING CODE SAMPLE

**RG A** - **TH55** - **RB** **L**  
 style fabric color size

## DEMO VIDEO



You can contact us too for customized embroidered or screen printed company logos, lettering, custom designed ESD clothing.

### DETAILS ON PAGE 113

| SIZE CHART (CM) | XS | S   | M   | L   | XL  | XXL | 3XL | 4XL | 5XL |
|-----------------|----|-----|-----|-----|-----|-----|-----|-----|-----|
| Length external | 49 | 51  | 53  | 55  | 57  | 59  | 61  | 63  | 65  |
| Hip             | 98 | 102 | 107 | 111 | 115 | 119 | 123 | 128 | 132 |

Size tolerance (before washing): 2%



Clothing certified according to the international ESD standards, as indicated by this/similar label



# WINTER LINE

---

CLOTHING STYLES

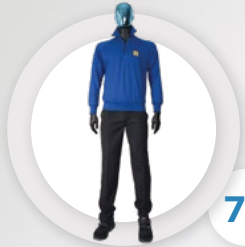

74

**CAS ESD CARDIGAN**

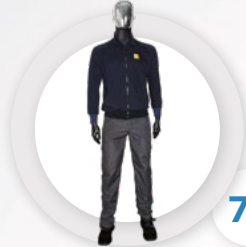

75

**CAL ESD CARDIGAN**

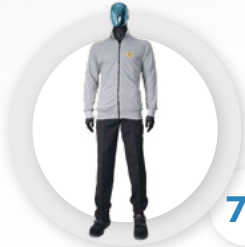

76

**CAL-H ESD CARDIGAN**



77

**SWS ESD SWEATSHIRT**

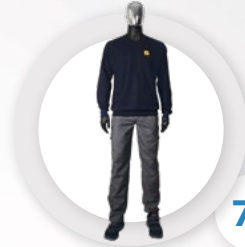

78

**SGS ESD SWEATSHIRT**

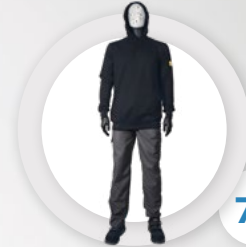

79

**SKS ESD SWEATSHIRT**

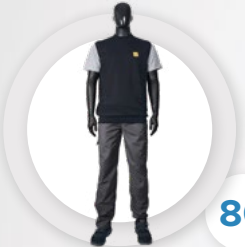

80

**SGW ESD VEST**

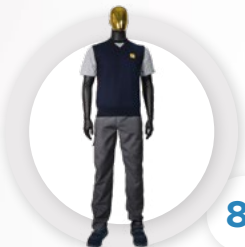

81

**SWW ESD VEST**



82

**SWW-Z ESD VEST**



83

**VES-S ESD QUILTED VEST**



84

**VES-H ESD QUILTED VEST**

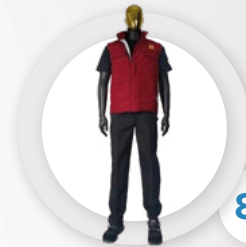

85

**VES-T ESD VEST**

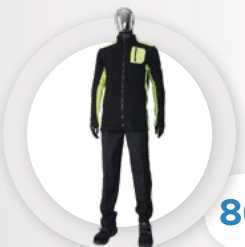

86

**FCU ESD CARDIGAN**



87

**FCF ESD CARDIGAN**



88

**FBU ESD CARDIGAN**



89

**FBF ESD CARDIGAN**



90

**FSU ESD CARDIGAN**



91

**FFF ESD CARDIGAN**



92

**WJ ESD WINTER JACKET**



93

**WW ESD WINTER VEST**

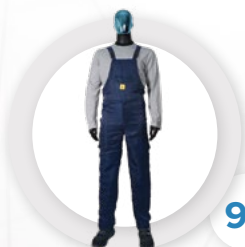

94

**WN ESD WINTER TROUSERS**



96

**WH ESD WINTER HAT**



97

**WS ESD TUBE SCARF**

# CAS ESD CARDIGAN



SHORT ZIPPER

## FEATURES

- » Standard sizes: Unisex XS - 5XL
- » With short zipper
- » 2 side pockets
- » ESD logo on the chest area
- » ESD cuff
- » Comfortable, breathable

## STANDARD FABRICS AND COLORS

THSS FABRIC



THSB FABRIC



You can contact us too for customized embroidered or screen printed company logos, lettering, custom designed ESD clothing.



**The sizechart below shows the dimensions before washing.**  
After washing, it should be calculated with a shrinkage of 8-10% for width (mainly for breast size).

## ORDERING CODE SAMPLE

**CAS - THSS - RB L**  
style fabric color size

DEMO VIDEO



The sizes given here meant values before washing.

**DETAILS ON PAGE 113**

Clothing certified according to the international ESD standards, as indicated by this/similar label



| SIZE CHART (CM) | XS  | S   | M   | L   | XL  | XXL | 3XL | 4XL | 5XL |
|-----------------|-----|-----|-----|-----|-----|-----|-----|-----|-----|
| Chest           | 108 | 112 | 116 | 120 | 124 | 130 | 136 | 142 | 148 |
| Length          | 64  | 66  | 68  | 70  | 72  | 74  | 76  | 78  | 80  |
| Sleeve          | 72  | 74  | 76  | 78  | 80  | 82  | 84  | 84  | 85  |

Size tolerance (before washing): 2%

**!** We suggest to determine personal size with measurement on washed clothes.

# CAL ESD CARDIGAN

LONG ZIPPER 

## FEATURES

- » Standard sizes: Unisex XS - 5XL
- » With full length zipper
- » 2 side pockets
- » ESD logo on the chest area
- » ESD cuff
- » Comfortable, breathable

## STANDARD FABRICS AND COLORS

THSS FABRIC 



THSB FABRIC 



You can contact us too for customized embroidered or screen printed company logos, lettering, custom designed ESD clothing. 

The sizechart below shows the dimensions before washing. After washing, it should be calculated with a shrinkage of 8-10% for width (mainly for breast size). 

## ORDERING CODE SAMPLE

**CAL** - **THSS** - **NB L**  
 style fabric color size

DEMO VIDEO 



The sizes given here meant values before washing.

DETAILS ON PAGE 113

| SIZE CHART (CM) | XS  | S   | M   | L   | XL  | XXL | 3XL | 4XL | 5XL |
|-----------------|-----|-----|-----|-----|-----|-----|-----|-----|-----|
| Chest           | 108 | 112 | 116 | 120 | 124 | 130 | 136 | 142 | 148 |
| Length          | 64  | 66  | 68  | 70  | 72  | 74  | 76  | 78  | 80  |
| Sleeve          | 72  | 74  | 76  | 78  | 80  | 82  | 84  | 84  | 85  |

Size tolerance (before washing): 2%

We suggest to determine personal size with measurement on washed clothes. 



Clothing certified according to the international ESD standards, as indicated by this/similar label

# CAL-H ESD CARDIGAN

LONG ZIPPER, STANDING COLLAR

## FEATURES

- » Standard sizes: Unisex XS - 5XL
- » Standing collar
- » With full length zipper
- » 2 side pockets
- » ESD logo on the chest area
- » ESD cuff
- » Comfortable, breathable

## STANDARD FABRICS AND COLORS

### THSS FABRIC



### THSB FABRIC



You can contact us too for customized embroidered or screen printed company logos, lettering, custom designed ESD clothing.



**The sizechart below shows the dimensions before washing.**  
After washing, it should be calculated with a shrinkage of 8-10% for width (mainly for breast size).

## ORDERING CODE SAMPLE

**CAL-H - THSS - GA L**  
style fabric color size

VIDEO / WEBPAGE



Clothing certified according to the international ESD standards, as indicated by this/similar label



The sizes given here meant values before washing.

**DETAILS ON PAGE 113**

| SIZE CHART (CM) | XS  | S   | M   | L   | XL  | XXL | 3XL | 4XL | 5XL |
|-----------------|-----|-----|-----|-----|-----|-----|-----|-----|-----|
| Chest           | 108 | 112 | 116 | 120 | 124 | 130 | 136 | 142 | 148 |
| Length          | 64  | 66  | 68  | 70  | 72  | 74  | 76  | 78  | 80  |
| Sleeve          | 72  | 74  | 76  | 78  | 80  | 82  | 84  | 84  | 85  |

Size tolerance (before washing): 2%

**!** We suggest to determine personal size with measurement on washed clothes.

# SWS ESD SWEATSHIRT

ROUND NECK 

## FEATURES

- » Standard sizes: Unisex XS - 5XL
- » Round neck
- » ESD logo on the chest area
- » ESD cuff

## STANDARD FABRICS AND COLORS

THSS FABRIC 



THSB FABRIC 



You can contact us too for customized embroidered or screen printed company logos, lettering, custom designed ESD clothing. 

The sizechart below shows the dimensions before washing. After washing, it should be calculated with a shrinkage of 8-10% for width (mainly for breast size). 

## ORDERING CODE SAMPLE

**SWS** - **THSS** - **NB** **L**  
 style fabric color size

DEMO VIDEO 



The sizes given here meant values before washing.

DETAILS ON PAGE 113

| SIZE CHART (CM) | XS  | S   | M   | L   | XL  | XXL | 3XL | 4XL | 5XL |
|-----------------|-----|-----|-----|-----|-----|-----|-----|-----|-----|
| Chest           | 108 | 112 | 116 | 120 | 124 | 130 | 136 | 142 | 148 |
| Length          | 64  | 66  | 68  | 70  | 72  | 74  | 76  | 78  | 80  |
| Sleeve          | 72  | 74  | 76  | 78  | 80  | 82  | 84  | 84  | 85  |



Clothing certified according to the international ESD standards, as indicated by this/similar label

Size tolerance (before washing): 2%

We suggest to determine personal size with measurement on washed clothes. 

# SGS ESD SWEATSHIRT



V-NECK

## FEATURES

- » Standard sizes: Unisex XS - 5XL
- » V-neck
- » ESD logo on the chest area
- » ESD cuff

## STANDARD FABRICS AND COLORS

### THSS FABRIC



### THSB FABRIC



You can contact us too for customized embroidered or screen printed company logos, lettering, custom designed ESD clothing.



**The sizechart below shows the dimensions before washing.**  
After washing, it should be calculated with a shrinkage of 8-10% for width (mainly for breast size).

## ORDERING CODE SAMPLE

**SGS - THSS - NB L**  
style fabric color size

DEMO VIDEO



Clothing certified according to the international ESD standards, as indicated by this/similar label



The sizes given here meant values before washing.

**DETAILS ON PAGE 113**

| SIZE CHART (CM) | XS  | S   | M   | L   | XL  | XXL | 3XL | 4XL | 5XL |
|-----------------|-----|-----|-----|-----|-----|-----|-----|-----|-----|
| Chest           | 108 | 112 | 116 | 120 | 124 | 130 | 136 | 142 | 148 |
| Length          | 64  | 66  | 68  | 70  | 72  | 74  | 76  | 78  | 80  |
| Sleeve          | 72  | 74  | 76  | 78  | 80  | 82  | 84  | 84  | 85  |

Size tolerance (before washing): 2%

**!** We suggest to determine personal size with measurement on washed clothes.



# SKS ESD HOODED SWEATSHIRT

## FEATURES

- » Standard sizes: Unisex XS - 5XL
- » Hood with drawstring
- » With ESD logo on sleeve
- » ESD cuff
- » Kangaroo pocket

## STANDARD FABRICS AND COLORS

### THSS FABRIC



### THSB FABRIC



You can contact us too for customized embroidered or screen printed company logos, lettering, custom designed ESD clothing.



The sizechart below shows the dimensions before washing.

After washing, it should be calculated with a shrinkage of 8-10% for width (mainly for breast size).



## ORDERING CODE SAMPLE

**SKS** - **THSS** - **BK L**  
 style fabric color size

## DEMO VIDEO



The sizes given here meant values before washing.

DETAILS ON PAGE 112

| SIZE CHART (CM) | XS  | S   | M   | L   | XL  | XXL | 3XL | 4XL | 5XL |
|-----------------|-----|-----|-----|-----|-----|-----|-----|-----|-----|
| Sleeve          | 52  | 53  | 57  | 61  | 63  | 65  | 67  | 67  | 68  |
| Length          | 64  | 66  | 68  | 70  | 72  | 74  | 76  | 76  | 76  |
| Chest           | 100 | 106 | 112 | 118 | 124 | 130 | 136 | 142 | 148 |
| Shoulder        | 41  | 43  | 45  | 47  | 49  | 51  | 54  | 57  | 60  |



Clothing certified according to the international ESD standards, as indicated by this/similar label

Size tolerance (before washing): 2%

We suggest to determine personal size with measurement on washed clothes.

# SGW ESD VEST



ROUND NECK

## FEATURES

- » Standard sizes: Unisex XS - 5XL
- » Round neck
- » ESD logo on the chest area

## STANDARD FABRICS AND COLORS

### THSS FABRIC



### THSB FABRIC



You can contact us too for customized embroidered or screen printed company logos, lettering, custom designed ESD clothing.



The sizechart below shows the dimensions before washing. After washing, it should be calculated with a shrinkage of 8-10% for width (mainly for breast size).

## ORDERING CODE SAMPLE

**SGW** - **THSS** - **BK** **L**  
 style fabric color size

DEMO VIDEO



The sizes given here meant values before washing.

**DETAILS ON PAGE 113**

Clothing certified according to the international ESD standards, as indicated by this/similar label



| SIZE CHART (CM) | XS  | S   | M   | L   | XL  | XXL | 3XL | 4XL | 5XL |
|-----------------|-----|-----|-----|-----|-----|-----|-----|-----|-----|
| Chest           | 100 | 106 | 112 | 118 | 124 | 130 | 136 | 142 | 148 |
| Length          | 63  | 66  | 69  | 72  | 75  | 78  | 81  | 84  | 87  |
| Shoulder        | 41  | 43  | 45  | 47  | 49  | 51  | 54  | 57  | 60  |

Size tolerance (before washing): 2%

! We suggest to determine personal size with measurement on washed clothes.

# SWW ESD VEST

V-NECK

## FEATURES

- » Standard sizes: Unisex XS - 5XL
- » V-neck
- » ESD logo on the chest area

## STANDARD FABRICS AND COLORS

### THSS FABRIC



### THSB FABRIC



You can contact us too for customized embroidered or screen printed company logos, lettering, custom designed ESD clothing.



The sizechart below shows the dimensions before washing. After washing, it should be calculated with a shrinkage of 8-10% for width (mainly for breast size).



## ORDERING CODE SAMPLE

**SWW** - **THSS** - **NB** **L**  
 style fabric color size

DEMO VIDEO



The sizes given here meant values before washing.

DETAILS ON PAGE 113

| SIZE CHART (CM) | XS  | S   | M   | L   | XL  | XXL | 3XL | 4XL | 5XL |
|-----------------|-----|-----|-----|-----|-----|-----|-----|-----|-----|
| Chest           | 100 | 106 | 112 | 118 | 124 | 130 | 136 | 142 | 148 |
| Length          | 63  | 66  | 69  | 72  | 75  | 78  | 81  | 84  | 87  |
| Shoulder        | 41  | 43  | 45  | 47  | 49  | 51  | 54  | 57  | 60  |



Clothing certified according to the international ESD standards, as indicated by this/similar label

Size tolerance (before washing): 2%

We suggest to determine personal size with measurement on washed clothes. !

# SWW-Z ESD VEST

V-NECK, ZIPPER

## FEATURES

- » Standard sizes: Unisex XS - 5XL
- » V-neck
- » With full length zipper
- » ESD logo on the chest area

## STANDARD FABRICS AND COLORS

### THSS FABRIC



### THSB FABRIC



You can contact us too for customized embroidered or screen printed company logos, lettering, custom designed ESD clothing.



**The sizechart below shows the dimensions before washing.**  
After washing, it should be calculated with a shrinkage of 8-10% for width (mainly for breast size).

## ORDERING CODE SAMPLE

**SWW-Z - THSS - GA L**  
style fabric color size

VIDEO / WEBPAGE



Clothing certified according to the international ESD standards, as indicated by this/similar label



The sizes given here meant values before washing.

**DETAILS ON PAGE 113**

| SIZE CHART (CM) | XS  | S   | M   | L   | XL  | XXL | 3XL | 4XL | 5XL |
|-----------------|-----|-----|-----|-----|-----|-----|-----|-----|-----|
| Chest           | 100 | 106 | 112 | 118 | 124 | 130 | 136 | 142 | 148 |
| Length          | 63  | 66  | 69  | 72  | 75  | 78  | 81  | 84  | 87  |
| Shoulder        | 41  | 43  | 45  | 47  | 49  | 51  | 54  | 57  | 60  |

Size tolerance (before washing): 2%

**!** We suggest to determine personal size with measurement on washed clothes.

# VES-S ESD QUILTED VEST

V-NECK

## FEATURES

- » Standard sizes: Unisex XS - 5XL
- » Quilted lining
- » Hidden snap-fasteners
- » ESD logo on the chest area
- » 2 side pockets
- » Not waterproof

## STANDARD FABRICS AND COLORS

CT35 FABRIC

W

You can contact us too for customized embroidered or screen printed company logos, lettering, custom designed ESD clothing.



## ORDERING CODE SAMPLE

**VES-S** - **CT35** - **W** **L**  
 style fabric color size

DEMO VIDEO



DETAILS ON PAGE 113

| SIZE CHART (CM) | XS  | S   | M   | L   | XL  | XXL | 3XL | 4XL | 5XL |
|-----------------|-----|-----|-----|-----|-----|-----|-----|-----|-----|
| Chest           | 102 | 110 | 118 | 126 | 132 | 138 | 144 | 150 | 154 |
| Length          | 64  | 66  | 68  | 70  | 72  | 74  | 76  | 78  | 80  |

Size tolerance (before washing): 2%



Clothing certified according to the international ESD standards, as indicated by this/similar label

# VES-H ESD QUILTED VEST

ZIPPER, STANDING COLLAR

## FEATURES

- » Standard sizes: Unisex XS - 5XL
- » Quilted lining
- » ESD logo on the chest area
- » 2 side pockets
- » Not waterproof

## STANDARD FABRICS AND COLORS

CT35 FABRIC

W



You can contact us too for customized embroidered or screen printed company logos, lettering, custom designed ESD clothing.

## ORDERING CODE SAMPLE

**VES-H** - **CT35** - **W L**  
 style fabric color size

DEMO VIDEO



DETAILS ON PAGE 113

Clothing certified according to the international ESD standards, as indicated by this/similar label



| SIZE CHART (CM) | XS  | S   | M   | L   | XL  | XXL | 3XL | 4XL | 5XL |
|-----------------|-----|-----|-----|-----|-----|-----|-----|-----|-----|
| Chest           | 102 | 110 | 118 | 126 | 132 | 138 | 144 | 150 | 154 |
| Length          | 64  | 66  | 68  | 70  | 72  | 74  | 76  | 78  | 80  |

Size tolerance (before washing): 2%

# VES-T ESD VEST

QUILTED LINING

## FEATURES

- » Standard sizes: Unisex XS – 5XL
- » White, quilted lining
- » Zipper
- » ESD logo on the chest area
- » 2 side pockets
- » Not waterproof, for indoor use

## STANDARD FABRICS AND COLORS

|             |    |    |    |     |             |    |             |    |               |   |
|-------------|----|----|----|-----|-------------|----|-------------|----|---------------|---|
| KK01 FABRIC |    |    |    |     | TH55 FABRIC |    |             |    | CR10HI FABRIC |   |
| BK          | DZ | DG | GA | LG  | RB          | LB | GA          | W  | O             | Y |
| NB          | RB | LB | MG | LE  | CR10 FABRIC |    | CT35 FABRIC |    | WC10 FABRIC   |   |
| B           | R  | O  | Y  | LPK | LB          | W  | W           | NB |               |   |
| W           |    |    |    |     |             |    |             |    |               |   |

You can contact us too for customized embroidered or screen printed company logos, lettering, custom designed ESD clothing.



## ORDERING CODE SAMPLE

**VES-T** - **KK01** - **B** **L**  
 style fabric color size

VIDEO / WEBPAGE



DETAILS ON PAGE 113

| SIZE CHART (CM)    | XS | S  | M   | L   | XL  | XXL | 3XL | 4XL | 5XL |
|--------------------|----|----|-----|-----|-----|-----|-----|-----|-----|
| Chest              | 90 | 98 | 106 | 114 | 122 | 130 | 136 | 142 | 148 |
| Length at the back | 70 | 71 | 72  | 73  | 74  | 75  | 76  | 77  | 78  |

Size tolerance (before washing): 2%



Clothing certified according to the international ESD standards, as indicated by this/similar label

# FCU ESD FLEECE CARDIGAN

LONG ZIPPER AND COLORED INSERTS

## FEATURES

- » Standard sizes: Unisex XS – 5XL
- » Coloured inserts: **CR10HI-O or Y**
- » Zipper
- » Standing collar
- » ESD logo on sleeve
- » 2 side pockets, 1 breast pocket for identity card
- » Not waterproof, for indoor use

## STANDARD FABRICS AND COLORS

### FL1 FABRIC



### FOR COLORED INSERTS

### CR10HI FABRIC



You can contact us too for customized embroidered or screen printed company logos, lettering, custom designed ESD clothing.

## ORDERING CODE SAMPLE

**FCU** - **FL1** - **BK** / **Y** **L**  
 style fabric color colored insert size

VIDEO / WEBPAGE



Clothing certified according to the international ESD standards, as indicated by this/similar label



DETAILS ON PAGE 112

| SIZE CHART (CM) | XS  | S   | M   | L   | XL  | XXL | 3XL | 4XL | 5XL |
|-----------------|-----|-----|-----|-----|-----|-----|-----|-----|-----|
| Chest           | 102 | 106 | 110 | 114 | 118 | 122 | 126 | 130 | 134 |
| Length          | 65  | 68  | 71  | 74  | 77  | 80  | 83  | 86  | 89  |
| Sleeve          | 55  | 57  | 59  | 61  | 63  | 65  | 67  | 67  | 68  |
| Shoulder        | 42  | 43  | 44  | 45  | 46  | 47  | 48  | 49  | 49  |

Size tolerance (before washing): 2%



# FCF ESD FEMALE FLEECE CARDIGAN

LONG ZIPPER AND COLORED INSERTS

## FEATURES

- » Standard sizes: Female XS – 5XL
- » Coloured inserts: **CR10HI-O or Y**
- » Zipper
- » Standing collar
- » ESD logo on sleeve
- » 2 side pockets, 1 breast pocket for identity card
- » Not waterproof, for indoor use

## STANDARD FABRICS AND COLORS

### FL1 FABRIC



### FOR COLORED INSERTS

### CR10HI FABRIC



You can contact us too for customized embroidered or screen printed company logos, lettering, custom designed ESD clothing.



## ORDERING CODE SAMPLE

**FCF** - **FL1** - **NB** / **O** **L**  
 style fabric color colored insert size

## VIDEO / WEBPAGE



### DETAILS ON PAGE 112

| SIZE CHART (CM) | XS  | S   | M   | L   | XL  | XXL | 3XL | 4XL | 5XL |
|-----------------|-----|-----|-----|-----|-----|-----|-----|-----|-----|
| Chest           | 102 | 106 | 110 | 114 | 118 | 122 | 126 | 130 | 134 |
| Length          | 62  | 65  | 68  | 71  | 74  | 77  | 80  | 83  | 83  |
| Sleeve          | 55  | 57  | 59  | 61  | 63  | 65  | 67  | 67  | 68  |
| Shoulder        | 42  | 43  | 44  | 45  | 46  | 47  | 48  | 49  | 49  |

Size tolerance (before washing): 2%



Clothing certified according to the international ESD standards, as indicated by this/similar label

# FBU ESD FLEECE CARDIGAN

LONG ZIPPER AND INSIDE COLORED COLLAR

## FEATURES

- » Standard sizes: Unisex XS – 5XL
- » Coloured inserts
- » Zipper
- » Standing collar
- » ESD logo on sleeve
- » 2 side pockets
- » Not waterproof, for indoor use

## STANDARD FABRICS AND COLORS

### FL1 FABRIC



### FOR COLORED INSERTS

### FL1 FABRIC



You can contact us too for customized embroidered or screen printed company logos, lettering, custom designed ESD clothing.

## VIDEO / WEBPAGE



## ORDERING CODE SAMPLE

**FBU** - **FL1** - **NB** / **Y** **L**  
style fabric color colored insert size

Clothing certified according to the international ESD standards, as indicated by this/similar label



### DETAILS ON PAGE 112

| SIZE CHART (CM) | XS  | S   | M   | L   | XL  | XXL | 3XL | 4XL | 5XL |
|-----------------|-----|-----|-----|-----|-----|-----|-----|-----|-----|
| Chest           | 102 | 106 | 110 | 114 | 118 | 122 | 126 | 130 | 134 |
| Length          | 65  | 68  | 71  | 74  | 77  | 80  | 83  | 86  | 89  |
| Sleeve          | 55  | 57  | 59  | 61  | 63  | 65  | 67  | 67  | 68  |
| Shoulder        | 42  | 43  | 44  | 45  | 46  | 47  | 48  | 49  | 49  |

Size tolerance (before washing): 2%

# FBF ESD FEMALE FLEECE CARDIGAN

LONG ZIPPER AND INSIDE COLORED COLLAR

## FEATURES

- » Standard sizes: Female XS – 5XL
- » Coloured inserts
- » Zipper
- » Standing collar
- » ESD logo on sleeve
- » 2 side pockets
- » Not waterproof, for indoor use

## STANDARD FABRICS AND COLORS

FOR COLORED INSERTS

FL1 FABRIC



FL1 FABRIC



You can contact us too for customized embroidered or screen printed company logos, lettering, custom designed ESD clothing.



## ORDERING CODE SAMPLE

**FBF** - **FL1** - **NB** / **O** **L**  
 style fabric color colored insert size

VIDEO / WEBPAGE



DETAILS ON PAGE 112

| SIZE CHART (CM) | XS  | S   | M   | L   | XL  | XXL | 3XL | 4XL | 5XL |
|-----------------|-----|-----|-----|-----|-----|-----|-----|-----|-----|
| Chest           | 102 | 106 | 110 | 114 | 118 | 122 | 126 | 130 | 134 |
| Length          | 62  | 65  | 68  | 71  | 74  | 77  | 80  | 83  | 83  |
| Sleeve          | 55  | 57  | 59  | 61  | 63  | 65  | 67  | 67  | 68  |
| Shoulder        | 42  | 43  | 44  | 45  | 46  | 47  | 48  | 49  | 49  |

Size tolerance (before washing): 2%



Clothing certified according to the international ESD standards, as indicated by this/similar label

# FSU ESD FLEECE CARDIGAN



LONG ZIPPER

## FEATURES

- » Standard sizes: Unisex XS – 5XL
- » Standing collar
- » ESD logo on sleeve
- » 2 side pockets, 1 breast pocket for identity card
- » Not waterproof, for indoor use

## STANDARD FABRICS AND COLORS

FL1 FABRIC



You can contact us too for customized embroidered or screen printed company logos, lettering, custom designed ESD clothing.

VIDEO / WEBPAGE



## ORDERING CODE SAMPLE

**FSU** - **FL1** - **DG** **L**  
 style fabric color size

Clothing certified according to the international ESD standards, as indicated by this/similar label



**DETAILS ON PAGE 112**

| SIZE CHART (CM) | XS  | S   | M   | L   | XL  | XXL | 3XL | 4XL | 5XL |
|-----------------|-----|-----|-----|-----|-----|-----|-----|-----|-----|
| Chest           | 102 | 106 | 110 | 114 | 118 | 122 | 126 | 130 | 134 |
| Length          | 65  | 68  | 71  | 74  | 77  | 80  | 83  | 86  | 89  |
| Sleeve          | 55  | 57  | 59  | 61  | 63  | 65  | 67  | 67  | 68  |
| Shoulder        | 42  | 43  | 44  | 45  | 46  | 47  | 48  | 49  | 49  |

Size tolerance (before washing): 2%

# FFF ESD FEMALE FLEECE CARDIGAN

LONG ZIPPER 

## FEATURES

- » Standard sizes: Female XS – 5XL
- » Standing collar
- » ESD logo on sleeve
- » 2 side pockets, 1 breast pocket for identity card
- » Not waterproof, for indoor use

## STANDARD FABRICS AND COLORS

FL1 FABRIC 



You can contact us too for customized embroidered or screen printed company logos, lettering, custom designed ESD clothing. 

## ORDERING CODE SAMPLE

**FFF** - **FL1** - **O** **L**  
 style fabric color size

VIDEO / WEBPAGE 



### DETAILS ON PAGE 112

| SIZE CHART (CM) | XS  | S   | M   | L   | XL  | XXL | 3XL | 4XL | 5XL |
|-----------------|-----|-----|-----|-----|-----|-----|-----|-----|-----|
| Chest           | 102 | 106 | 110 | 114 | 118 | 122 | 126 | 130 | 134 |
| Length          | 62  | 65  | 68  | 71  | 74  | 77  | 80  | 83  | 83  |
| Sleeve          | 55  | 57  | 59  | 61  | 63  | 65  | 67  | 67  | 68  |
| Shoulder        | 42  | 43  | 44  | 45  | 46  | 47  | 48  | 49  | 49  |

Size tolerance (before washing): 2%



Clothing certified according to the international ESD standards, as indicated by this/similar label

# WJ ESD WINTER JACKET



STANDING COLLAR

## FEATURES

- » Standard sizes: Unisex XS - 5XL
- » Fleece lining
- » Water-repellent outer layer
- » ESD logo on the chest area
- » 2 side pockets
- » Hidden zipper

## STANDARD FABRICS AND COLORS

WC10 FABRIC

NB



You can contact us too for customized embroidered or screen printed company logos, lettering, custom designed ESD clothing.

DEMO VIDEO



## ORDERING CODE SAMPLE

**WJ - WC10 - NB L**  
 style fabric color size

Clothing certified according to the international ESD standards, as indicated by this/similar label



DETAILS ON PAGE 112

| SIZE CHART (CM) | XS  | S   | M   | L   | XL  | XXL | 3XL | 4XL | 5XL |
|-----------------|-----|-----|-----|-----|-----|-----|-----|-----|-----|
| Chest           | 124 | 128 | 132 | 136 | 140 | 144 | 148 | 152 | 156 |
| Sleeve          | 62  | 63  | 64  | 65  | 68  | 68  | 69  | 69  | 70  |
| Length          | 78  | 79  | 80  | 81  | 82  | 83  | 84  | 85  | 86  |

Size tolerance (before washing): 2%

# WW ESD WINTER VEST

STANDING COLLAR ○

## FEATURES ○

- » Standard sizes: Unisex XS - 5XL
- » Fleece lining
- » Water-repellent outer layer
- » ESD logo on the chest area
- » 2 side pockets
- » Hidden zipper

## STANDARD FABRICS AND COLORS ○

WC10 FABRIC ○

**NB**

You can contact us too for customized embroidered or screen printed company logos, lettering, custom designed ESD clothing.



## ORDERING CODE SAMPLE ○

**WW** - **WC10** - **NB** **L**  
 style fabric color size

DEMO VIDEO ○



DETAILS ON PAGE 113

| SIZE CHART (CM) | XS  | S   | M   | L   | XL  | XXL | 3XL | 4XL | 5XL |
|-----------------|-----|-----|-----|-----|-----|-----|-----|-----|-----|
| Chest           | 130 | 132 | 136 | 140 | 144 | 150 | 154 | 158 | 162 |
| Length          | 70  | 71  | 72  | 73  | 74  | 75  | 76  | 77  | 78  |

Size tolerance (before washing): 2%



Clothing certified according to the international ESD standards, as indicated by this/similar label

# WN ESD WINTER TROUSERS WITH BRIDLES



## FEATURES

- » Standard sizes: Unisex XS - 5XL
- » Fleece lining
- » Water-repellent outer layer
- » 2 side pockets, 1 front pocket with ESD logo
- » 2 side pockets on legs
- » 2 quick release buckles

## STANDARD FABRICS AND COLORS

### WC10 FABRIC

NB



You can contact us too for customized embroidered or screen printed company logos, lettering, custom designed ESD clothing.

### DEMO VIDEO



## ORDERING CODE SAMPLE

**WN** - **WC10** - **NB** **L**  
 style fabric color size

Clothing certified according to the international ESD standards, as indicated by this/similar label



DETAILS ON PAGE 113

| SIZE CHART (CM) | XS  | S   | M   | L   | XL  | XXL | 3XL | 4XL | 5XL |
|-----------------|-----|-----|-----|-----|-----|-----|-----|-----|-----|
| Length external | 104 | 106 | 108 | 110 | 112 | 114 | 116 | 118 | 119 |
| Hip             | 102 | 107 | 111 | 115 | 119 | 123 | 128 | 132 | 136 |
| Bridle length   | 62  | 63  | 64  | 64  | 66  | 66  | 68  | 68  | 70  |

Size tolerance (before washing): 2%





# WH ESD WINTER HAT



## FEATURES

- » Standard sizes: Unisex, one size
- » With ESD logo
- » Comfortable
- » Warm and breathable

## STANDARD FABRICS AND COLORS

### PS21 FABRIC



### FL1 FABRIC



You can contact us too for customized embroidered or screen printed company logos, lettering, custom designed ESD clothing.

## ORDERING CODE SAMPLE

**WH** - **PS21** - **NB**  
style fabric color

## DEMO VIDEO



Clothing certified according to the international ESD standards, as indicated by this/similar label



# WS ESD SCARF

## FEATURES

- » Standard sizes: Unisex, one size
- » With ESD logo
- » Comfortable
- » Warm and breathable

## STANDARD FABRICS AND COLORS

### FL1 FABRIC



### PS21 FABRIC



You can contact us too for customized embroidered or screen printed company logos, lettering, custom designed ESD clothing.



## DEMO VIDEO



## ORDERING CODE SAMPLE

**WS** - **PS21** - **NB**  
style fabric color



Clothing certified according to the international ESD standards, as indicated by this/similar label

## UTB ESD UTILITY BAG



### DIMENSIONS

- » 220 x 100 x 100 mm

## PKTT ESD BOTTLE HOLDER



### DIMENSIONS

- » 120 mm diameter
- » 290 mm length

CONTACT US IF YOU HAVE DEMAND FOR CUSTOMIZED ESD CLOTHING, ESD CLOTHING PRODUCT.

## BUM ESD BELT BAG



### DIMENSIONS

- » **Width:** 240 mm
- » **Height:** 160 mm
- » **Depth:** 25 mm
- » **Upper zipper length:** 180 mm
- » **Lower zipper length:** 160 mm

## KV1 ESD ARM COVER



### INDICATIVE DIMENSIONS

- » **XS** – 270 mm diameter, 450 mm length
- » **S** – 400 mm diameter, 600 mm length
- » **M** – 500 mm diameter, 600 mm length
- » **L** – 600 mm diameter, 700 mm length

**NH ESD  
WASHABLE HAIR NET**



**BPK CAP WITH  
BUN HOLDER**



CONTACT US IF YOU HAVE DEMAND FOR CUSTOMIZED  
ESD CLOTHING, ESD CLOTHING PRODUCT.

**COVER ESD COVER**



**CURT ESD CURTAIN**





# CLEANROOM LINE

---

CLOTHING STYLES



102

**COV CLEANROOM COVERALL**



103

**COVH CLEANROOM COVERALL**

WITH HOOD



104

**COA CLEANROOM COAT**



105

**JAC CLEANROOM JACKET  
TRU CLEANROOM TROUSERS**



106

**FCH CLEANROOM FULL COVER HOOD**



107

**FMS CLEANROOM FACE MASK**



108

**STG CLEANROOM SHOES**  
WITH TEXTILE GAITER

# COV CLEANROOM COVERALL



## FEATURES

- » Standard sizes: 3XS - 4XL
- » Double covered front zipper
- » Adjustable waistband inside
- » Standing collar with snaps
- » Raglan sleeve
- » Conductive elasticated cuffs at the wrist and ankle ends
- » ESD logo on the chest area

## OPTIONAL

- + Chest, hip or bottom pockets
- + Card holder, pen holder
- + Company logo

## STANDARD FABRICS AND COLORS

### CR10 FABRIC

LB

W



Individual custom made ESD clothing is also available

## ORDERING CODE SAMPLE

**COV** - **CR10** - **LB** **L**  
 style fabric color size

### VIDEO / WEBPAGE



Clothing certified according to the international ESD standards, as indicated by this/similar label



DETAILS ON PAGE 114

| SIZE CHART (CM)                  | 3XS   | XXS   | XS    | S     | M     | L     | XL    | XXL   | 3XL   | 4XL   |
|----------------------------------|-------|-------|-------|-------|-------|-------|-------|-------|-------|-------|
| Chest circumference              | 113,5 | 119,0 | 125,5 | 131,5 | 135,5 | 143,0 | 151,5 | 155,0 | 160,0 | 166,0 |
| Waist circumference              | 90,0  | 93,5  | 99,0  | 103,5 | 109,0 | 116,5 | 124,5 | 133,0 | 140,0 | 150,0 |
| Hip circumference                | 106,0 | 111,0 | 114,0 | 119,0 | 122,0 | 128,0 | 136,0 | 150,0 | 155,0 | 162,0 |
| Back length to the hip           | 51,0  | 54,0  | 55,0  | 55,5  | 58,0  | 60,0  | 62,0  | 64,5  | 70,0  | 75,0  |
| Side length                      | 99,5  | 103,0 | 105,5 | 107,0 | 112,0 | 119,0 | 124,0 | 127,0 | 135,5 | 139,0 |
| Inseam length                    | 70,5  | 73,5  | 75,0  | 77,0  | 79,0  | 86,0  | 91,0  | 94,5  | 100,0 | 103,0 |
| Thigh circumference              | 59,0  | 61,0  | 63,0  | 66,0  | 70,0  | 72,0  | 76,0  | 79,0  | 82,0  | 86,0  |
| Upper arm circumference          | 39,0  | 42,0  | 45,0  | 49,0  | 50,0  | 53,5  | 56,0  | 57,0  | 58,0  | 60,0  |
| Sleeve length from the neck area | 74,0  | 75,0  | 76,0  | 79,0  | 80,0  | 82,0  | 85,0  | 86,0  | 88,0  | 90,0  |

Size tolerance (before washing): 3%; shrinkage after cleaning: 3-5%



# COVH CLEANROOM COVERALL

WITH INTEGRATED HOOD

## FEATURES

## OPTIONAL

- + Chest, hip or bottom pockets
- + Card holder, pen holder
- + Company logo
- » Standard sizes: 3XS - 4XL
- » Double covered front zipper
- » Adjustable waistband inside
- » Snaps at neck
- » Raglan sleeve
- » Conductive elasticated cuffs at the wrist and ankle ends
- » Open face area
- » Adjustable by snaps at the back of hood
- » Snap-fasteners for face mask
- » ESD logo on the chest area

## STANDARD FABRICS AND COLORS

CR10 FABRIC



Individual custom made ESD clothing is also available



## ORDERING CODE SAMPLE

**COVH** - **CR10** - **W L**  
 style fabric color size

VIDEO / WEBPAGE



DETAILS ON PAGE 114

| SIZE CHART (CM)            | 3XS   | XXS   | XS    | S     | M     | L     | XL    | XXL   | 3XL   | 4XL   |
|----------------------------|-------|-------|-------|-------|-------|-------|-------|-------|-------|-------|
| Chest circumference        | 113,5 | 119,0 | 125,5 | 131,5 | 135,5 | 143,0 | 151,5 | 155,0 | 160,0 | 166,0 |
| Waist circumference        | 90,0  | 93,5  | 99,0  | 103,5 | 109,0 | 116,5 | 124,5 | 133,0 | 140,0 | 150,0 |
| Hip circumference          | 106,0 | 111,0 | 114,0 | 119,0 | 122,0 | 128,0 | 136,0 | 150,0 | 155,0 | 162,0 |
| Back length to the hip     | 49,0  | 52,0  | 53,0  | 53,5  | 56,0  | 58,0  | 60,0  | 62,5  | 68,0  | 71,0  |
| Side length                | 99,5  | 103,0 | 105,5 | 107,0 | 112,0 | 119,0 | 124,0 | 127,0 | 135,5 | 143,0 |
| Inseam length              | 70,5  | 73,5  | 75,0  | 77,0  | 79,0  | 86,0  | 91,0  | 94,5  | 100,0 | 103,0 |
| Thigh circumference        | 59,0  | 61,0  | 63,0  | 66,0  | 70,0  | 72,0  | 76,0  | 79,0  | 82,0  | 86,0  |
| Forehead circumference     | 60,0  | 60,0  | 60,0  | 61,0  | 63,0  | 65,0  | 68,0  | 71,0  | 74,0  | 77,0  |
| Face opening circumference | 76,0  | 77,0  | 78,0  | 80,0  | 82,0  | 84,0  | 86,0  | 88,0  | 90,0  | 92,0  |

Size tolerance (Before washing): 3%; shrinkage by decontamination: 3-5%



Clothing certified according to the international ESD standards, as indicated by this/similar label

# COA CLEANROOM COAT



## FEATURES

- » Standard sizes: 3XS-4XL
- » Double covered front zipper
- » Standing collar with snaps
- » Raglan sleeve
- » Conductive elasticated cuffs at the wrist ends
- » Extra long coat
- » ESD logo on the chest area

## OPTIONAL

- + Chest, hip or bottom pockets
- + Adjustable waistband inside
- + Card holder, pen holder
- + Company logo

## STANDARD FABRICS AND COLORS

### CR10 FABRIC

LB

W



Individual custom made ESD clothing is also available

## ORDERING CODE SAMPLE

**COA** - **CR10** - **LB L**  
 style fabric color size

VIDEO / WEBPAGE



Clothing certified according to the international ESD standards, as indicated by this/similar label



DETAILS ON PAGE 114

| SIZE CHART (CM)                  | 3XS   | XXS   | XS    | S     | M     | L     | XL    | XXL   | 3XL   | 4XL   |
|----------------------------------|-------|-------|-------|-------|-------|-------|-------|-------|-------|-------|
| Chest circumference              | 113,5 | 119,0 | 125,5 | 131,5 | 135,5 | 143,0 | 151,5 | 155,0 | 160,0 | 166,0 |
| Waist circumference              | 105,5 | 109,0 | 115,0 | 117,0 | 126,0 | 131,5 | 138,0 | 143,5 | 150,0 | 160,0 |
| Hip circumference                | 113,0 | 117,0 | 121,0 | 123,5 | 131,0 | 140,5 | 145,5 | 150,0 | 155,0 | 162,0 |
| Back length                      | 109,0 | 111,0 | 113,0 | 114,5 | 119,0 | 124,0 | 125,5 | 125,5 | 125,5 | 125,5 |
| Neck circumference               | 39,0  | 40,5  | 41,5  | 43,0  | 44,0  | 45,5  | 51,0  | 52,0  | 54,0  | 55,0  |
| Upper arm circumference          | 41,0  | 44,0  | 46,5  | 49,0  | 50,5  | 53,0  | 56,0  | 57,0  | 58,5  | 61,5  |
| Sleeve length from the neck area | 73,0  | 75,0  | 77,0  | 80,0  | 82,5  | 83,5  | 86,0  | 87,5  | 88,0  | 90,5  |

Size tolerance (Before washing): 3%; shrinkage by decontamination: 3-5%

# JAC CLEANROOM JACKET AND TRU CLEANROOM TROUSERS

## JACKET FEATURES

- » Standard sizes: 3XS-4XL
- » Front zipper
- » Standing collar with snaps
- » Raglan sleeve
- » Conductive elasticated cuffs at the wrist ends
- » ESD logo on the chest area

## OPTIONAL

- + Chest, hip or bottom pockets
- + Card holder, pen holder
- + Company logo

## ORDERING CODE SAMPLE

**JAC - CR10 - W L**  
 style fabric color size

## TROUSERS FEATURES

- » Standard sizes: 3XS-4XL
- » Adjustable waistband
- » Conductive elasticated cuffs at the ankle ends
- » With ESD logo

## OPTIONAL

- + Pockets
- + Company logo

## ORDERING CODE SAMPLE

**TRU - CR10 - W L**  
 style fabric color size

## STANDARD FABRICS AND COLORS

CR10 FABRIC

LB

W

DETAILS ON PAGE 115

Size charts (cm)

| JAC CLEANROOM JACKET             | 3XS   | XXS   | XS    | S     | M     | L     | XL    | XXL   | 3XL   | 4XL   |
|----------------------------------|-------|-------|-------|-------|-------|-------|-------|-------|-------|-------|
| Chest circumference              | 106,0 | 109,0 | 112,0 | 116,0 | 124,0 | 131,0 | 136,0 | 141,0 | 146,0 | 154,0 |
| Waist circumference              | 99,0  | 102,0 | 105,0 | 109,0 | 117,0 | 124,0 | 129,0 | 134,0 | 139,0 | 147,0 |
| Hip circumference                | 115,0 | 118,0 | 121,0 | 125,0 | 133,0 | 140,0 | 145,0 | 150,0 | 155,0 | 163,0 |
| Back length                      | 73,5  | 75,5  | 78,5  | 81,5  | 85,5  | 88,0  | 90,0  | 92,5  | 94,0  | 94,0  |
| Neck circumference               | 45,0  | 46,5  | 47,5  | 48,0  | 50,0  | 55,0  | 57,0  | 59,0  | 59,0  | 59,0  |
| TRU CLEANROOM TROUSERS           | 3XS   | XXS   | XS    | S     | M     | L     | XL    | XXL   | 3XL   | 4XL   |
| Waist circumference (Contracted) | 75,0  | 78,0  | 80,0  | 83,0  | 87,0  | 90,0  | 99,0  | 103,0 | 107,0 | 114,0 |
| Waist circumference (Expanded)   | 98,0  | 102,0 | 104,0 | 108,0 | 113,0 | 116,0 | 128,0 | 133,0 | 138,0 | 146,0 |
| Crotch circumference             | 108,0 | 111,0 | 114,0 | 118,0 | 120,0 | 123,0 | 133,0 | 138,0 | 143,0 | 149,0 |
| Trousers length                  | 103,0 | 105,0 | 107,0 | 110,5 | 113,0 | 116,0 | 121,0 | 125,0 | 127,0 | 131,0 |
| Inseam                           | 74,0  | 75,5  | 78,0  | 80,0  | 82,0  | 84,5  | 88,0  | 90,0  | 92,0  | 94,0  |
| Thigh circumference              | 58,0  | 59,0  | 61,0  | 62,0  | 63,0  | 66,0  | 71,0  | 74,0  | 78,0  | 82,0  |

Size tolerance (Before washing): 3%; shrinkage by decontamination: 3-5%



VIDEO / WEBPAGE



Clothing certified according to the international ESD standards, as indicated by this/similar label



Individual custom made ESD clothing is also available

# FCH CLEANROOM FULL COVER HOOD



## FEATURES

- » Standard sizes: XXS-XXL
- » Front zipper
- » Flat top
- » Adjustable by snaps behind
- » Open face
- » Snap-fasteners for face mask
- » With ESD logo

## OPTIONAL

- + Company logo

## STANDARD FABRICS AND COLORS

### CR10 FABRIC

LB

W



Individual custom made ESD clothing is also available

## ORDERING CODE SAMPLE

**FCH** - **CR10** - **LB** **L**  
 style fabric color size

## VIDEO / WEBPAGE



Clothing certified according to the international ESD standards, as indicated by this/similar label



## DETAILS ON PAGE 115

| SIZE CHART (CM) | XXS  | XS   | S    | M    | L    | XL   | XXL  |
|-----------------|------|------|------|------|------|------|------|
| E               | 23,5 | 24,5 | 26,0 | 26,0 | 28,5 | 28,5 | 28,5 |
| H               | 13,0 | 14,0 | 15,0 | 16,0 | 17,0 | 17,0 | 17,0 |
| A1              | 52,0 | 55,0 | 58,0 | 61,0 | 63,5 | 66,0 | 69,0 |
| G               | 6,0  | 6,0  | 6,0  | 6,0  | 6,5  | 6,5  | 6,5  |
| S               | 21,0 | 21,0 | 21,0 | 21,0 | 21,0 | 21,0 | 21,0 |

Size tolerance (Before washing): 3%; shrinkage by decontamination: 3-5%

# FMS CLEANROOM FACE MASK

## FEATURES

- » One size
- » With snaps that can be attached to a hood
- » For COVH or FCH products, not usable on its own.

## STANDARD FABRICS AND COLORS

CR10 FABRIC

LB

W

Individual custom made ESD clothing is also available



## VIDEO / WEBPAGE



## ORDERING CODE SAMPLE

**FMS** - **CR10** - **W**  
 style fabric color



### DETAILS ON PAGE 115

| SIZE CHART (CM) | Size |
|-----------------|------|
| A               | 25,0 |
| B               | 6,0  |
| C               | 31,0 |
| D               | 30,0 |

Size tolerance (Before washing): 3%; shrinkage by decontamination: 3-5%

# STG CLEANROOM SHOES

WITH TEXTILE GAITER

## FEATURES

- » Front zipper
- » Comfortable shoes
- » Conductive soles
- » Adjustable ribbon with velcro
- » With ESD logo

## STANDARD FABRICS AND COLORS

CR10 FABRIC

W



Individual custom made ESD clothing is also available

## ORDERING CODE SAMPLE

**STG** - **CR10** - **W** **41**  
style fabric color size

## VIDEO / WEBPAGE



STANDARD SIZES

36 37,5 38,5 40 41 42 43 44,5 45,5 46,5

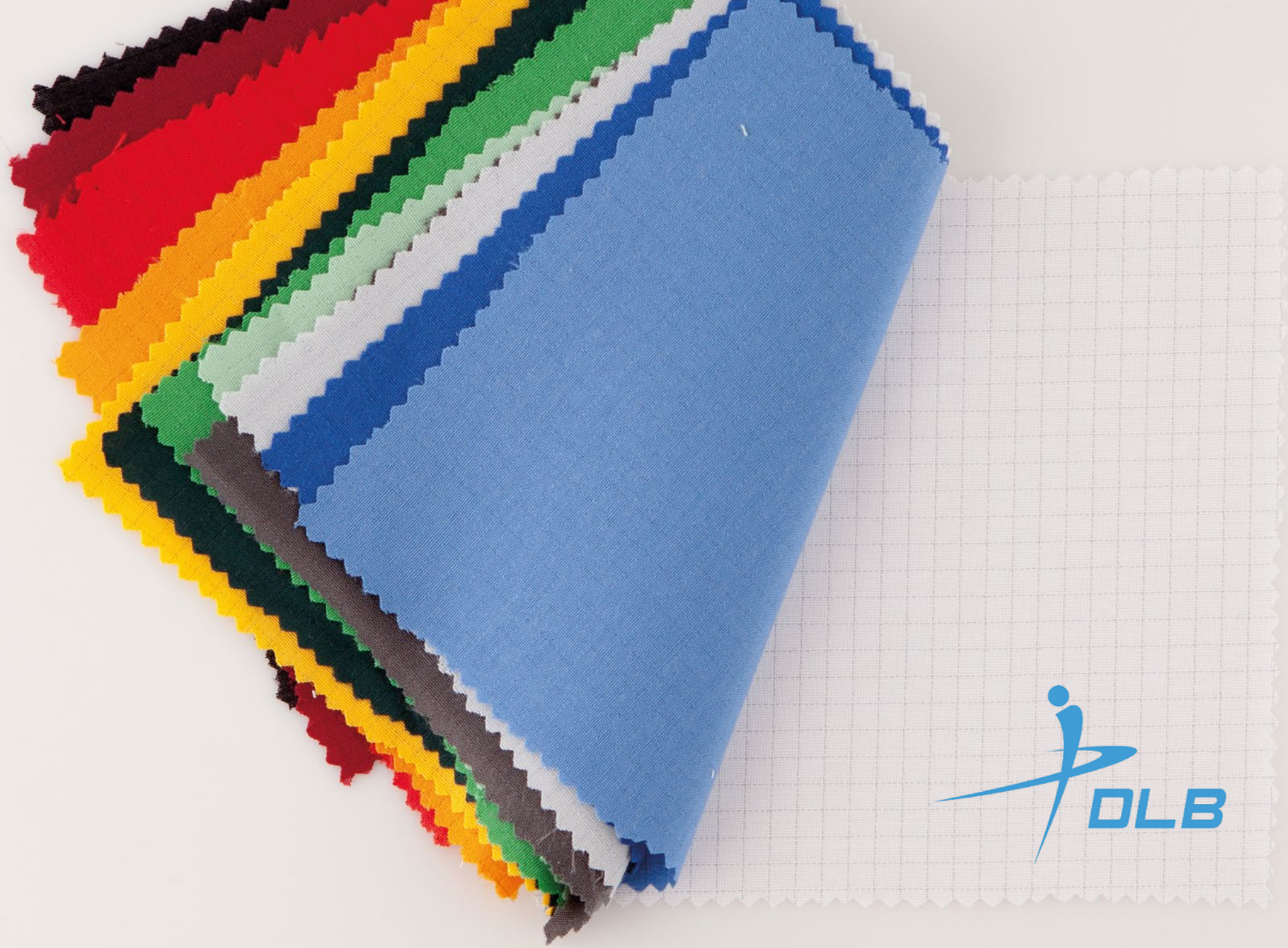

**PGO/F PGZ/F TGO/F TGZ/F**  
**TKO/F TKZ/F TLY**

○ **DESCRIPTION**

1. Sleeve
2. Chest
3. Length
4. Shoulder

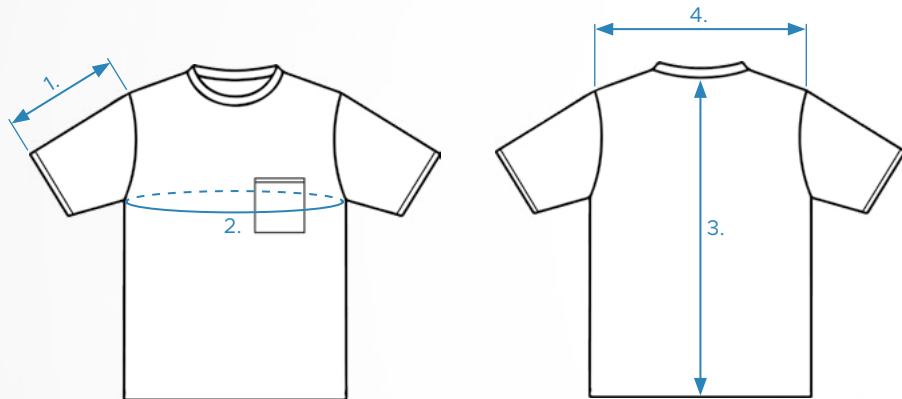

**ING IFG LGO/F LGZ/F LKO/F LKZ/F**  
**QGO/F QGZ/F SKS WJ FCU**  
**FCF FBU FBF FSU FFF**

○ **DESCRIPTION**

1. Sleeve
2. Chest
3. Length
4. Shoulder
5. Cuff

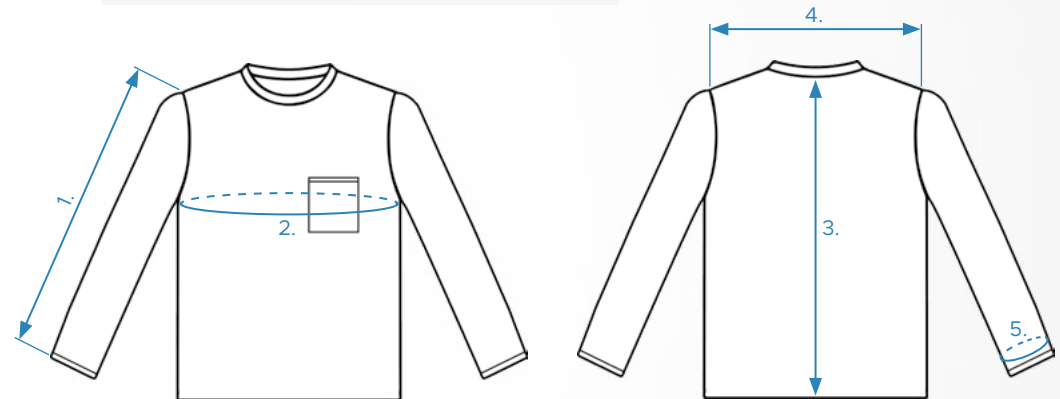

○ **SIZE CHART FOR FEMALE SHORT SLEEVE T-SHIRTS AND POLO-SHIRTS**

**PGOF PGZF TGOF TGZF TKOF TKZF**

| SIZE CHART (CM) | XS   | S    | M    | L    | XL  | XXL  | 3XL | 4XL  | 5XL |
|-----------------|------|------|------|------|-----|------|-----|------|-----|
| Sleeve          | 20,5 | 21,5 | 22,5 | 23,5 | 25  | 26,5 | 28  | 29,5 | 31  |
| Length          | 63   | 66   | 69   | 72   | 75  | 78   | 81  | 84   | 87  |
| Chest           | 82   | 86   | 91   | 96   | 102 | 110  | 114 | 118  | 122 |
| Waist           | 66   | 70   | 75   | 80   | 86  | 94   | 98  | 104  | 108 |
| Hip             | 90   | 94   | 99   | 105  | 111 | 117  | 123 | 129  | 135 |
| Shoulder        | 39   | 40   | 41   | 42   | 43  | 44   | 45  | 46   | 47  |

Size tolerance (before washing): 2%

○ **SIZE CHART FOR FEMALE LONG SLEEVE T-SHIRTS AND POLO-SHIRTS**

**LGOF LGZF LKOF LKZF QGOF QGZF**

| SIZE CHART (CM) | XS   | S  | M  | L   | XL  | XXL | 3XL | 4XL | 5XL |
|-----------------|------|----|----|-----|-----|-----|-----|-----|-----|
| Sleeve          | 51,5 | 53 | 57 | 61  | 63  | 65  | 67  | 67  | 68  |
| Length          | 63   | 66 | 69 | 72  | 75  | 78  | 81  | 84  | 87  |
| Chest           | 82   | 86 | 91 | 96  | 102 | 110 | 114 | 118 | 122 |
| Waist           | 66   | 70 | 75 | 80  | 86  | 94  | 98  | 104 | 108 |
| Hip             | 90   | 94 | 99 | 105 | 111 | 117 | 123 | 129 | 135 |
| Shoulder        | 39   | 40 | 41 | 42  | 43  | 44  | 45  | 46  | 47  |

Size tolerance (before washing): 2%



**EFL EFS EFX ESL ESS ESX OJ**  
**PF1 PS1 PF2 PS2 PF3 PS3**

**DESCRIPTION**

- 1. Chest
- 2. Shoulder
- 3. Sleeve
- 4. Length
- 5. Cuff
- 6. Hip

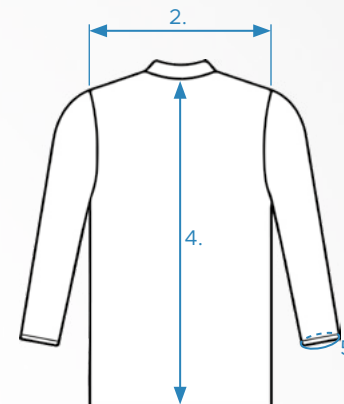
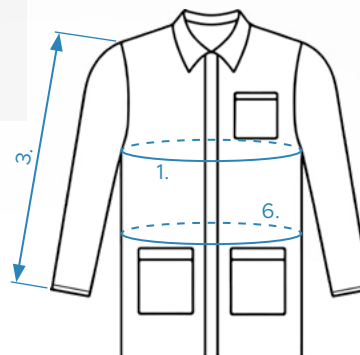

**HIV SGW SWW SWW-Z**  
**VES-H VES-S VES-T WW**

**DESCRIPTION**

- 1. Chest
- 2. Length (length at the back in the case of VES-T)
- 3. Shoulder

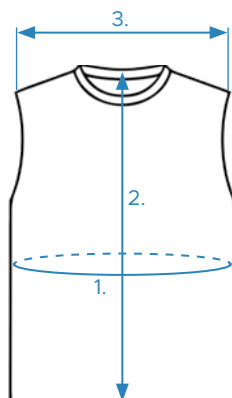

**CAS CAL CAL-H**  
**SWS SGS**

**DESCRIPTION**

- 1. Sleeve
- 2. Chest
- 3. Length
- 4. Shoulder
- 5. Cuff

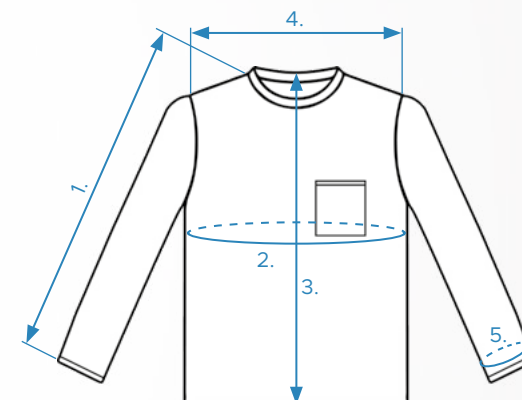

**ET ETF NT NTF**  
**OT RGA WN**

**DESCRIPTION**

- 1. Hip
- 2. Length external

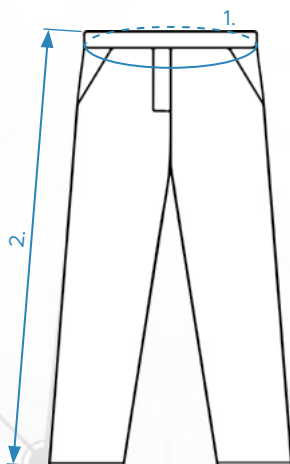

**SKI**

**DESCRIPTION**

- 1. Waist
- 2. Hip
- 3. Length

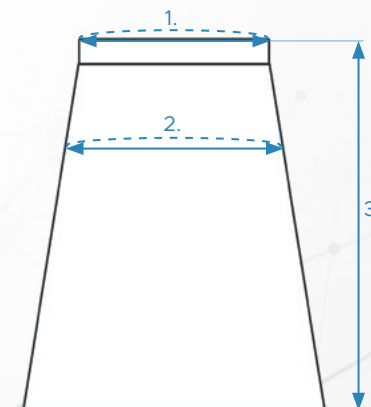

**COV COVH**

○ **DESCRIPTION**

- 1. Chest circumference
- 2. Waist circumference
- 3. Hip circumference
- 4. Back length to the hip
- 5. Side length
- 6. Inseam length
- 7. Thigh circumference
- 8. Upper arm circumference
- 9. Sleeve length from the neck area
- 10. Forehead circumference
- 11. Face opening circumference

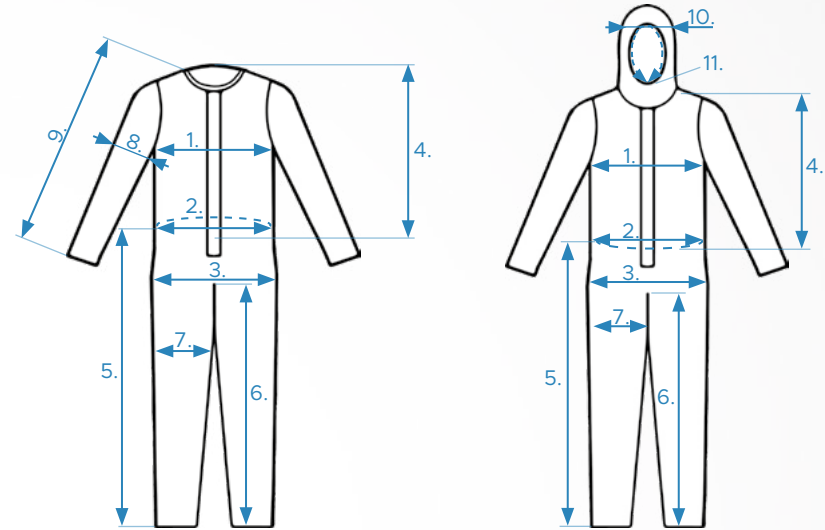

**COA**

○ **DESCRIPTION**

- 1. Chest circumference
- 2. Waist circumference
- 3. Hip circumference
- 4. Back length
- 5. Neck circumference
- 6. Upper arm circumference
- 7. Sleeve length from the neck area

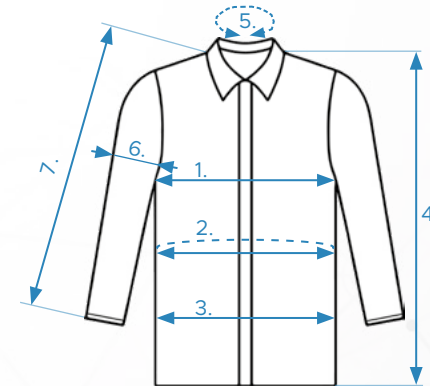

**JAC**

○ **DESCRIPTION**

- 1. Chest circumference
- 2. Waist circumference
- 3. Hip circumference
- 4. Back length
- 5. Neck circumference

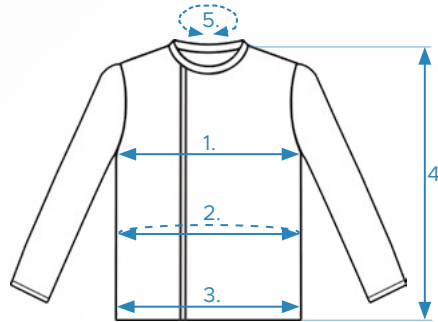

**TRU**

○ **DESCRIPTION**

- 1. Waist circumference (Contracted)
- 2. Waist circumference (Expanded)
- 3. Crotch circumference
- 4. Trousers length
- 5. Inseam
- 6. Thigh circumference

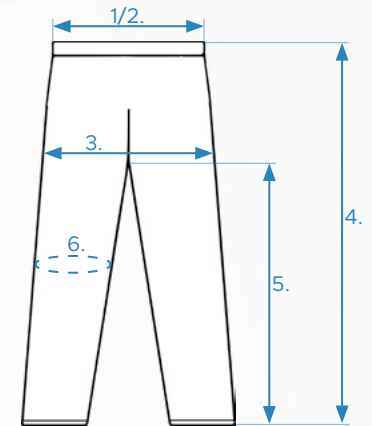

**FCH**

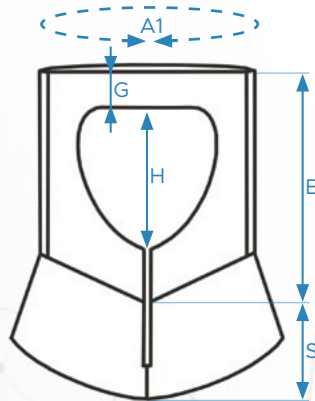

**FMS**

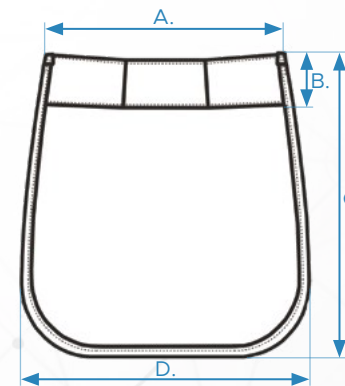



# LOGO DESIGN

---

Upon request, we can customize your clothing with your company logo or a personalized inscription.

Please send your logo in \*.jpg format via e-mail, we will prepare our offer to you.





[SCAN ME]

and download  
our latest  
garments  
catalogue



## **D és Tsa Bt.**

**Office and Warehouse:**  
2600 Vác, Galcsek u. 8-10.

**Phone:** +36 27 502 555

**Email:** sales@destsa.hu

**Web:** www.dlb.hu

